



John Berends Implements Pty Ltd

AGRICULTURAL ENGINEERS

OPERATOR'S MANUAL PARTS LIST



Landscape Rakes

PRODUCT NO.

0371	1.2m (4') Landscape Rake
0372	1.5m (5') Landscape Rake
0373	1.8m (6') Landscape Rake
0374	2.1m (7') Landscape Rake

130 FRANKSTON/DANDENONG RD, DANDENONG SOUTH, VIC. 3175 AUSTRALIA
PHONE (03) 9791 2494 FAX NO. (03) 9794 5568
www.johnberendsimplements.com.au

TABLE OF CONTENTS

	Page No.
SAFETY FEATURES.....	3
SAFETY INSTRUCTIONS.....	6
ASSEMBLY.....	7
OPERATION.....	7
MAINTENANCE.....	7
SPARE PARTS.....	8





SAFETY





Farm machinery is dangerous if operated incorrectly so please read this manual in its entirety prior to operating the machine.

 No operator, however experienced in farm machinery operation, should attempt to use any machine they have not been competently trained to use. Your local Department of Agriculture can help you with training, as can most Occupational Health and Safety offices, Agricultural schools and colleges and farm equipment dealerships.

 All instructions relating to tractor safety as per the tractor operators manual should be followed. When making any machine adjustments, stop the tractor engine first and wait for all moving parts to stop. Maintain the tractor to ensure it remains safe to use. Do not operate faulty or damaged equipment.

 Extreme caution should be taken when fitting equipment to the tractor's three point linkage. Avoid standing between the implement and the tractor when coupling machinery.

 All machines should be mounted and retained correctly. All guards must be kept in place and correctly maintained. P.T.O. shafts must be correctly attached and secured to both the tractor and the machine. Decals must be visible and legible at all times. Keep well clear of all moving parts.

 Keep all people and animals at a safe distance from all moving parts. Children must not be allowed to operate this equipment and all passengers must have the same level of protection as the operator.

 Wear protective clothing where appropriate.

 Never operate when tired (not alert) or in poorly lit areas and stay alert for humps and other hidden hazards. Remove all timber, rocks and foreign objects prior to operation.

 Avoid operating the machine in wet conditions.

 Exercise extreme caution when changing direction on hills. Avoid sudden movement, sudden breaking, high speeds, rough terrain and steep slopes.

 If machine starts to vibrate, stop tractor using method as described in the operation section

 After striking a foreign object or if there are doubts about the performance of the machine, stop the tractor as described and check if machine is making excessive noise.

 Extreme caution must be taken when working in public areas (roadsides etc). It is recommended that flaps and chains are fitted in these areas. These are available as optional extras. Rear flaps are compulsory in public areas.

 Do not modify this equipment in anyway, or use it for any other purpose than it was designed to do.

 Never work under unsupported machines or adjust unsupported machines. Do not enter the danger zone where a load being carried by a machine could fall on you, for example a round bale from a bale fork, a log from a carryall or material from a rear end loader.

These instructions should be used in conjunction with any local regulations regarding safety ie OHS.

Maintenance is essential for safe operation. Ensure maintenance is carried out regularly by people qualified to do so. This is of particular importance on P.T.O. drive machines where driven parts can fly off at high speed if wearing parts are not properly maintained.

FAILURE TO FOLLOW THESE INSTRUCTIONS AND PROCEDURES MAY RESULT IN EQUIPMENT MALFUNCTION, OR DAMAGE, SERIOUS INJURY OR EVEN DEATH.

INTRODUCTION:

This manual was developed specifically for the machine you have purchased. The information within is to assist you in preparing, operating and maintaining your machine. Please read and understand the contents of the manual completely before attempting to operate your machine, paying special attention to all safety details. With our policy of continuous improvement, products and specifications may change without notice and without incurring the obligation to install such changes on any unit previously delivered.

Landscape Rakes

The landscape rake was developed to provide a less aggressive option to our stick rakes. They use a 32 x 10mm hardened tine with double hole mounts. This prevents the tine from slipping sideways. The gap between each tine is 32mm. Three different settings for the rake pitch allow the aggressiveness of the tine to be adjusted. The third position is a floating one which allows the tines to hinge backwards on the frame. This can be used when operating the machine around rocks or stumps allowing the tines to lift up over the obstacles. There is enough weight in the frames to keep the tines on the ground under normal raking conditions.

MACHINE SPECIFICATIONS

MODEL	4'	5'	6'	7'
No of tines	18	23	28	33
Tine Size	32 x 10	32 x 10	32 x 10	32 x 10
Tractor H.P. (minimum)	16 H.P.	16 H.P.	20 H.P.	25 H.P.
Tractor CAT connection	Cat 1	Cat 1	Cat 1	Cat 1

WARRANTY

John Berends Implements P/L warrants each new product sold to be free from defects in material and workmanship, under normal use and service, as outlined in the operator's manual, for a period of 12 months.

This warranty is void if any damage to the machine has been caused by misuse or non genuine parts have been used or any repairs have been made by any persons other than authorised dealer service personnel.

The manufacturer/dealer is not obligated to any transportation charges incurred in the repair or replacement of parts.

This warranty does not exclude any condition or warranty implied by the Trade Practices Act 1974 or any other legislation which implies any condition which cannot be excluded.

© Copyright 2010 This Safety Manual is copyright and no part may be reproduced without the written permission of John Berends Implements.

Safety Features

1. SERIAL NUMBER (Decal)



2. WARNING DECAL



3. BERENDS DECAL

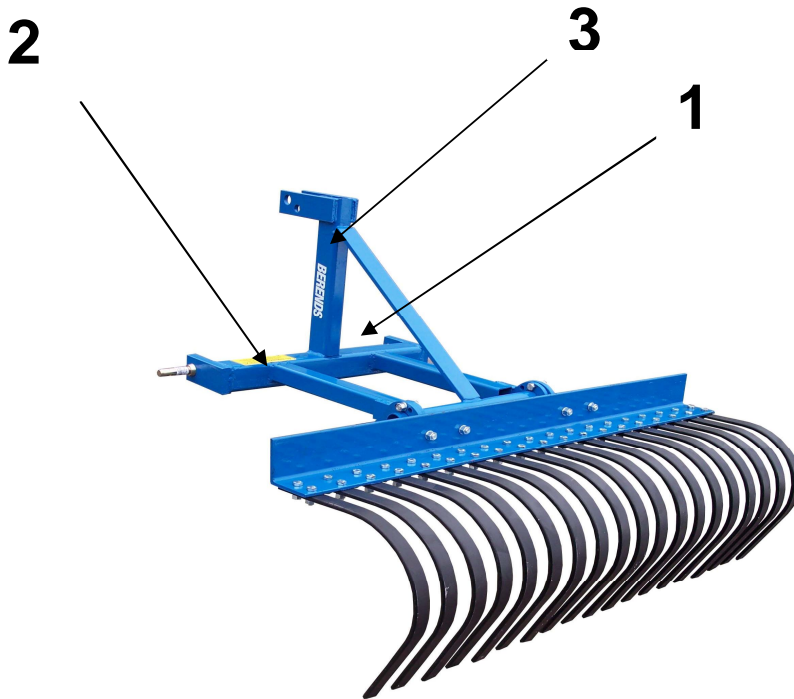

ASSEMBLY

Line the lower linkage arms between the lower linkage plates of the landscape rake, slide the linkage pins through the holes and secure with linch pins. Attach the top link to the landscape rake. It may be helpful to support the linkage at the right height with a stable block or similar. Sway chains or bars should be used to prevent the machine swinging around in use. Raise and lower the implement to ensure that the tractor does not come in contact with the rake.

OPERATION

Once all safety procedures have been followed, start the tractor and raise the landscape rake off the ground. Ensure the area is clear of foreign obstacles. Only lower the rake until it is just touching the ground. The tines are not designed for cultivating the soil.



Caution:

Only operate the landscape rake on even ground.

If you are unsure about the nature of the terrain it is advised that you operate the landscape rake in the float position. This is done by removing the two bolts that connect the headstock to the rake. Alternatively, you can adjust the pitch of these tines by repositioning these two bolts in one of the other hole positions

Turning

Lift the landscape rake off the ground. Never turn before the tines are completely free from the soil, otherwise the inner most tines will be forced sideways and backwards. Alternatively a large wide sweep can be taken providing the tines never move backward.

Reversing

Never reverse with the tines in the soil, but make sure the rake is fully raised. Reversing can overload the tines eventually leading to tine breakage.

Stopping

Lower the landscape rake, stop the tractor engine (removing the ignition key) and apply the park brake. Ensure that the landscape rake is well supported when not in use.

MAINTENANCE

When doing any type of maintenance on this machine, always follow the safety steps described in this manual. Use only authorised genuine parts for replacement. The landscape rake must be adequately supported under its body (Make certain it cannot fall).

Tines

Check all tine bolts are tight. Replace where necessary

SPARE PARTS

ORDER SPARE PARTS THROUGH YOUR ORIGINAL SUPPLIER OR YOUR LOCAL JOHN BERENDS IMPLEMENTS DEALER.

Always quote the machine serial number or product number, spare part number and its part name as stated in the operator's manual.

Landscape Rake (0371, 0372, 0373, 0374)

Key No.	Part No.	Quantity	Description
1	1630	ar	Tine 32 x 10mm
2	1631	ar	Bolt/nut/ to fit 1630 to frame
3	1967	2	Cat 1 bolt on pin

