



# John Berends Implements Pty Ltd

AGRICULTURAL ENGINEERS

## OPERATOR'S MANUAL PARTS LIST



### Stick Rakes

**PRODUCT NO.**

0043	6' Stick Rake bottom only
0044	7'6" Stick Rake bottom only
0045	9' Stick Rake bottom only
0046	10'6" Stick Rake bottom only
0138	Fixed Top
0139	Offset top
0342	7'6" Stick Rake complete with toolbar linkage – 15 tines
0343	9' Stick Rake complete with toolbar linkage – 19 tines
0344	10'6" Stick Rake complete with toolbar linkage – 21 tines

130 FRANKSTON/DANDENONG RD, DANDENONG SOUTH, VIC. 3175 AUSTRALIA

PHONE (03) 9791 2494

FAX NO. (03) 9794 5568

[www.johnberendsimplements.com.au](http://www.johnberendsimplements.com.au)

## TABLE OF CONTENTS

	Page No.
SAFETY FEATURES.....	3
SAFETY INSTRUCTIONS.....	6
ASSEMBLY.....	7
OPERATION.....	7
MAINTENANCE.....	8
SPARE PARTS.....	8





# SAFETY





Farm machinery is dangerous if operated incorrectly so please read this manual in its entirety prior to operating the machine.

 No operator, however experienced in farm machinery operation, should attempt to use any machine they have not been competently trained to use. Your local Department of Agriculture can help you with training, as can most Occupational Health and Safety offices, Agricultural schools and colleges and farm equipment dealerships.

 All instructions relating to tractor safety as per the tractor operators manual should be followed. When making any machine adjustments, stop the tractor engine first and wait for all moving parts to stop. Maintain the tractor to ensure it remains safe to use. Do not operate faulty or damaged equipment.

 Extreme caution should be taken when fitting equipment to the tractor's three point linkage. Avoid standing between the implement and the tractor when coupling machinery.

 All machines should be mounted and retained correctly. All guards must be kept in place and correctly maintained. P.T.O. shafts must be correctly attached and secured to both the tractor and the machine. Decals must be visible and legible at all times. Keep well clear of all moving parts.

 Keep all people and animals at a safe distance from all moving parts. Children must not be allowed to operate this equipment and all passengers must have the same level of protection as the operator.

 Wear protective clothing where appropriate.

 Never operate when tired (not alert) or in poorly lit areas and stay alert for humps and other hidden hazards. Remove all timber, rocks and foreign objects prior to operation.

 Avoid operating the machine in wet conditions.

 Exercise extreme caution when changing direction on hills. Avoid sudden movement, sudden breaking, high speeds, rough terrain and steep slopes.

 If machine starts to vibrate, stop tractor using method as described in the operation section

 After striking a foreign object or if there are doubts about the performance of the machine, stop the tractor as described and check if machine is making excessive noise.

 Extreme caution must be taken when working in public areas (roadsides etc). It is recommended that flaps and chains are fitted in these areas. These are available as optional extras. Rear flaps are compulsory in public areas.

 Do not modify this equipment in anyway, or use it for any other purpose than it was designed to do.

 Never work under unsupported machines or adjust unsupported machines. Do not enter the danger zone where a load being carried by a machine could fall on you, for example a round bale from a bale fork, a log from a carryall or material from a rear end loader.

These instructions should be used in conjunction with any local regulations regarding safety ie OHS.

**Maintenance is essential for safe operation. Ensure maintenance is carried out regularly by people qualified to do so. This is of particular importance on P.T.O. drive machines where driven parts can fly off at high speed if wearing parts are not properly maintained.**

**FAILURE TO FOLLOW THESE INSTRUCTIONS AND PROCEDURES MAY RESULT IN EQUIPMENT MALFUNCTION, OR DAMAGE, SERIOUS INJURY OR EVEN DEATH.**

**INTRODUCTION:**

This manual was developed specifically for the machine you have purchased. The information within is to assist you in preparing, operating and maintaining your machine. Please read and understand the contents of the manual completely before attempting to operate your machine, paying special attention to all safety details. With our policy of continuous improvement, products and specifications may change without notice and without incurring the obligation to install such changes on any unit previously delivered.

**Stick Rakes**

The range of stick rakes come with the option of a fixed top (no offset), toolbar headstock or an offset top which enables the rake to be operated outside the tractor wheels. All tines are spaced at 6" spacings and are fitted with replaceable points and other points are available for different applications. The toolbar is constructed from 2" square K1045 (high tensile) solid bar. Wheel kits can also be fitted to control depth.

**MACHINE SPECIFICATIONS**

MODEL	6'	7'6"	9'	10'6"
No of tines	11	15	19	21
Tine Size	32 x 10	32 x 10	32 x 10	32 x 10
Tractor H.P. (minimum)	16 H.P.	16 H.P.	25 H.P.	35 H.P.
Tractor CAT connection	Cat 1/2	Cat 1/2	Cat 1/2	Cat 1/2
Nett Weight (kg)	110	130	160	180

**WARRANTY**

John Berends Implements P/L warrants each new product sold to be free from defects in material and workmanship, under normal use and service, as outlined in the operators manual, for a period of 12 months.

This warranty is void if any damage to the machine has been caused by misuse or non genuine parts have been used or any repairs have been made by any persons other than authorised dealer service personnel.

The manufacturer/dealer is not obligated to any transportation charges incurred in the repair or replacement of parts.

This warranty does not exclude any condition or warranty implied by the Trade Practices Act 1974 or any other legislation which implies any condition which cannot be excluded.

© Copyright 1998      This Safety Manual is copyright and no part may be reproduced without the written permission of John Berends Implements.

# Safety Features

1. SERIAL NUMBER (Decal)



2. WARNING DECAL



3. BERENDS DECAL

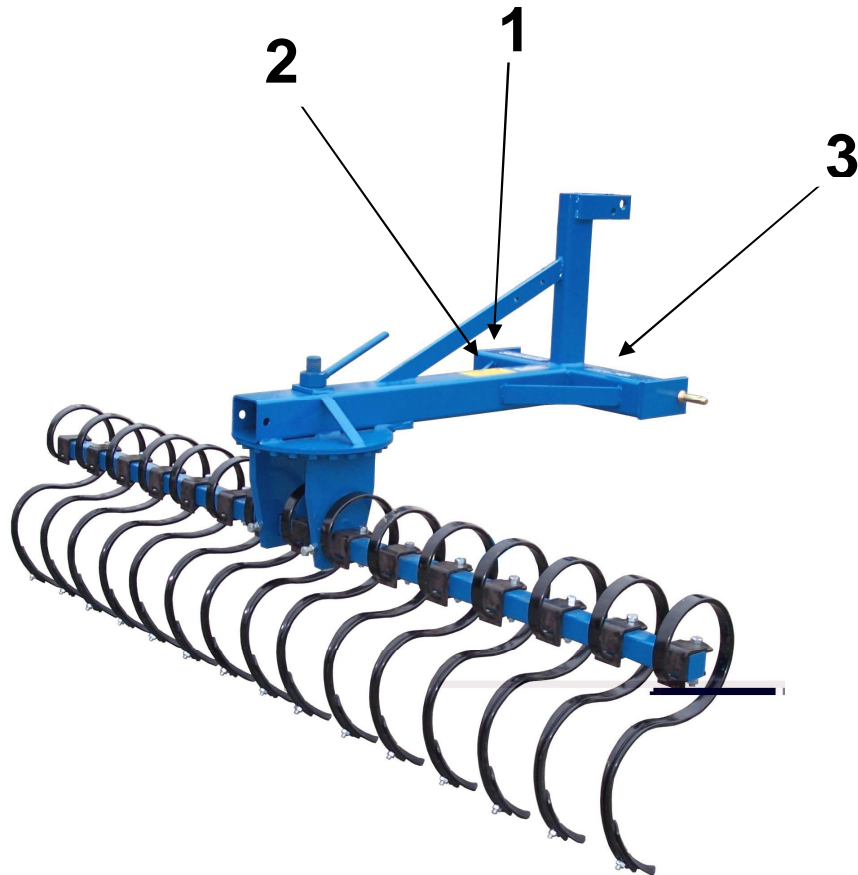

## ASSEMBLY

Line the lower linkage arms between the lower linkage plates of the stick rake top, slide the linkage pins through the holes and secure with linch pins. Attach the top link to the stick rake. It may be helpful to support the linkage at the right height with a stable block or similar. Sway chains or bars should be used to prevent the machine swinging around in use.

## OPERATION

Once all safety procedures have been followed, start the tractor and raise the stick rake off the ground

There are four positions of offset on either side of the rake (except for the standard fixed and toolbar models). The offset adjusting arm has to be mounted on the side on which the rake is required to be offset, left for left and right for right. It is adjusted by fitting the pin at the rear end of the adjusting arm in one of the four alternative holes in the beam. To do this level the machine so it will not swing around under its own weight, then remove the pin, move the rake beam across until the hole in the offset arms lines up with a hole in the beam at the desired offset.

The second adjustment is the angle. The rake is locked in position by a locking lug under the beam and is held tight by the pivot nut handle. Loosen the handle so that the rake drops below the locking index. This is best done by lifting the machine slightly off the ground using the linkage arms on the tractor. Rotate the rake to the desired angle and ensure the angle adjustment handle (nut handle) is secure. Apply some grease to the pivot pin to prevent it from seizing up over time.

**Always have the stick rake tines facing straight forward when operating to prevent tine damage. You will only need to adjust the angle when altering the offset position.**



### **Caution:**

When adjusting any stick rake angle or offset, make sure the machine is level so it will not swing around under its own weight.

The toolbar type can also be offset simply by knocking out the wedges holding the bar inside the clamps and relocating the toolbar to one side. Knock the wedges back in with a hammer to ensure they lock the toolbar in place.

The offset model will tilt via the linkage pins. When connecting the stick rake, position the tractors lower linkage arms in different holes to vary the tilt. The rake can be tilted from the tractor using the levelling box without altering the pins. There are probably not many situations where a stick rake will use a tilt function however it is still incorporated in the unit in case a grader blade is mounted at any stage.



### **Caution:**

Only operate the stick rake on even ground. If ground is undulating it is advised that depth wheels be mounted on either side to prevent excessive force on outer tines.

### **Turning**

Lift the stick rake off the ground. Never turn before the tines are completely free from the soil, otherwise the inner most tines will be forced sideways and backwards. Alternatively a large wide sweep can be taken providing the tines never move backward.

### **Reversing**

Never reverse with the tines in the soil, but make sure the rake is fully raised. Reversing can overload the tines eventually leading to tine breakage.

### **Stopping**

Lower the stick rake, stop the tractor engine (removing the ignition key) and apply the park brake. Ensure that the stick rake is well supported when not in use.

## **MAINTENANCE**

When doing any type of maintenance on this machine, always follow the safety steps described in this manual. Use only authorised genuine parts for replacement. The stick rake must be adequately supported under its body (Make certain it cannot fall).

### **Tines**

Check all tines clamps are tight. Ensure points are not too worn. If so they must be reversed or replaced before they wear the tine out.

### **Wheel kit**

Check tyre pressure. Wheel must run freely on axle and yoke must be lubricated. Note: Bearings are replaceable if necessary.

## **SPARE PARTS**

ORDER SPARE PARTS THROUGH YOUR ORIGINAL SUPPLIER OR YOUR LOCAL JOHN BERENDS IMPLEMENTS DEALER.

Always quote the machine serial number or product number, spare part number and its part name as stated in the operator's manual.



**Stick Rake (0044-0046, 0342-0344)**

Key No.	Part No.	Quantity	Description
1	1670	ar	Tine with point 32 x 10
2	3849	ar	Clamp bracket, bolt/nut/sw to fit 1670 to 50 x 50 frame
3	1678	ar	Reversible point
	1684	ar	Lucerne or grass point (optional)
4	1686	ar	Plough bolt/nut
5	3850	1	7'6" high tensile toolbar only
	3851	1	9' high tensile toolbar only
	3852	1	10'6" high tensile toolbar only
6	1514	1	Nut handle (angle adjustment on )
7	3853	1	Cog (angle) complete with pivot pin/support legs
8	1496	1	Pivot pin
9	3854	2	Toolbar locking bolts/square nuts
10	0587	2	Wedges hold clamp
11	1967	2	Cat 1 bolt on pin

