



John Berends Implements Pty Ltd

AGRICULTURAL ENGINEERS

OPERATOR'S MANUAL PARTS LIST

Post drivers

PRODUCT NO.

0263

Post Driver



130 FRANKSTON/DANDENONG RD, DANDENONG SOUTH, VIC. 3175 AUSTRALIA

Phone: (03) 9791 2494

Fax: (03) 9794 5568

www.johnberendsimplements.com.au

berends@johnberendsimplements.com.au

TABLE OF CONTENTS

	Page No.
SAFETY INSTRUCTIONS.....	3
INTRODUCTION.....	5
SAFETY FEATURES.....	6
ASSEMBLY.....	7
OPERATION.....	11
MAINTENANCE.....	13
SPARE PARTS.....	14





SAFETY





Farm machinery is dangerous if operated incorrectly so please read this manual in its entirety prior to operating the machine.

 No operator, however experienced in farm machinery operation, should attempt to use any machine they have not been competently trained to use. Your local Department of Agriculture can help you with training, as can most Occupational Health and Safety offices, Agricultural schools and colleges and farm equipment dealerships.

 All instructions relating to tractor safety as per the tractor operators manual should be followed. When making any machine adjustments, stop the tractor engine first and wait for all moving parts to stop. Maintain the tractor to ensure it remains safe to use. Do not operate faulty or damaged equipment.

 Extreme caution should be taken when fitting equipment to the tractor's three point linkage. Avoid standing between the implement and the tractor when coupling machinery.

 All machines should be mounted and retained correctly. All guards must be kept in place and correctly maintained. P.T.O. shafts must be correctly attached and secured to both the tractor and the machine. Decals must be visible and legible at all times. Keep well clear of all moving parts.

 Keep all people and animals at a safe distance from all moving parts. Children must not be allowed to operate this equipment and all passengers must have the same level of protection as the operator.

 Wear protective clothing where appropriate.

 Never operate when tired (not alert) or in poorly lit areas and stay alert for humps and other hidden hazards. Remove all timber, rocks and foreign objects prior to operation.

 Avoid operating the machine in wet conditions.

 Exercise extreme caution when changing direction on hills. Avoid sudden movement, sudden breaking, high speeds, rough terrain and steep slopes.



If machine starts to vibrate, stop tractor, turn off engine and investigate.



After striking a foreign object or if there are doubts about the performance of the machine, stop the tractor as described and check if machine is making excessive noise.



Extreme caution must be taken when working in public areas (roadsides etc). It is recommended that flaps and chains are fitted to slashers when operating in public areas. These are available as optional extras. Rear flaps are compulsory in public areas.



Watch overhead clearance and beware of underground pipes and cables.



Where fitted, hydraulic hoses and fittings must be maintained so as to prevent damage.



Do not modify this equipment in anyway, or use it for any other purpose than it was designed to do.



Never work under unsupported machines or adjust unsupported machines. Do not enter the danger zone where a load being carried by a machine could fall on you, for example a round bale from a bale fork, a log from a carryall or material from a rear end loader.

These instructions should be used in conjunction with any local regulations regarding safety ie OHS.

Maintenance is essential for safe operation. Ensure maintenance is carried out regularly by people qualified to do so. This is of particular importance on P.T.O. drive machines where driven parts can fly off at high speed if wearing parts are not properly maintained.

FAILURE TO FOLLOW THESE INSTRUCTIONS AND PROCEDURES MAY RESULT IN EQUIPMENT MALFUNCTION, OR DAMAGE, SERIOUS INJURY OR EVEN DEATH.

INTRODUCTION:

This manual was developed specifically for the machine you have purchased. The information within is to assist you in preparing, operating and maintaining your machine. Please read and understand the contents of the manual completely before attempting to operate your machine, paying special attention to all safety details. With our policy of continuous improvement, products and specifications may change without notice and without incurring the obligation to install such changes on any unit previously delivered.

Post Driver

The Berends post driver runs off a single set of standard remote hydraulics with no plumbing in the back axle required. The hydraulic ram operates the lever arm which is connected to the weight by a wire rope. The machine has a ratchet side tilt which can be replaced with a hydraulic ram if necessary. Fore and aft tilt is provided by adjusting the top link of the tractor. The post can be kept upright by clamping it to the sliding bracket on the main beam.

This machine is designed for tractors fitted with a standard set of remotes and capable of lifting 450kg at approximately 1000mm distance from the linkage arms when parked on a level surface. There are numerous variables that can affect the stability of the unit. These include the tractor model, the slope of the ground and the speed of the tractor. Ensure that the tractor and the area it is being operated in are suitable for using with this post driver.

MACHINE SPECIFICATIONS

MODEL	Post Driver
Max. Post Height (Linkage on ground)	2.9m
Dolly Weight (kg)	160
Overall Height	3.9m
Tractor CAT connection	Cat 1/ 2
Nett Weight (kg)	450

WARRANTY

John Berends Implements P/L warrants each new product sold to be free from defects in material and workmanship, under normal use and service, as outlined in the operators manual, for a period of 12 months.

This warranty is void if any damage to the machine has been caused by misuse or non genuine parts have been used or any repairs have been made by any persons other than authorised dealer service personnel.

The manufacturer/dealer is not obligated to any transportation charges incurred in the repair or replacement of parts.

This warranty does not exclude any condition or warranty implied by the Trade Practices Act 1974 or any other legislation which implies any condition which cannot be excluded.

Safety Features

1. SERIAL NUMBER DECAL



2. BERENDS DECAL

3. SAFETY CAGE

4. WARNING/SAFETY DECALS (The following decals should be prominently visible)

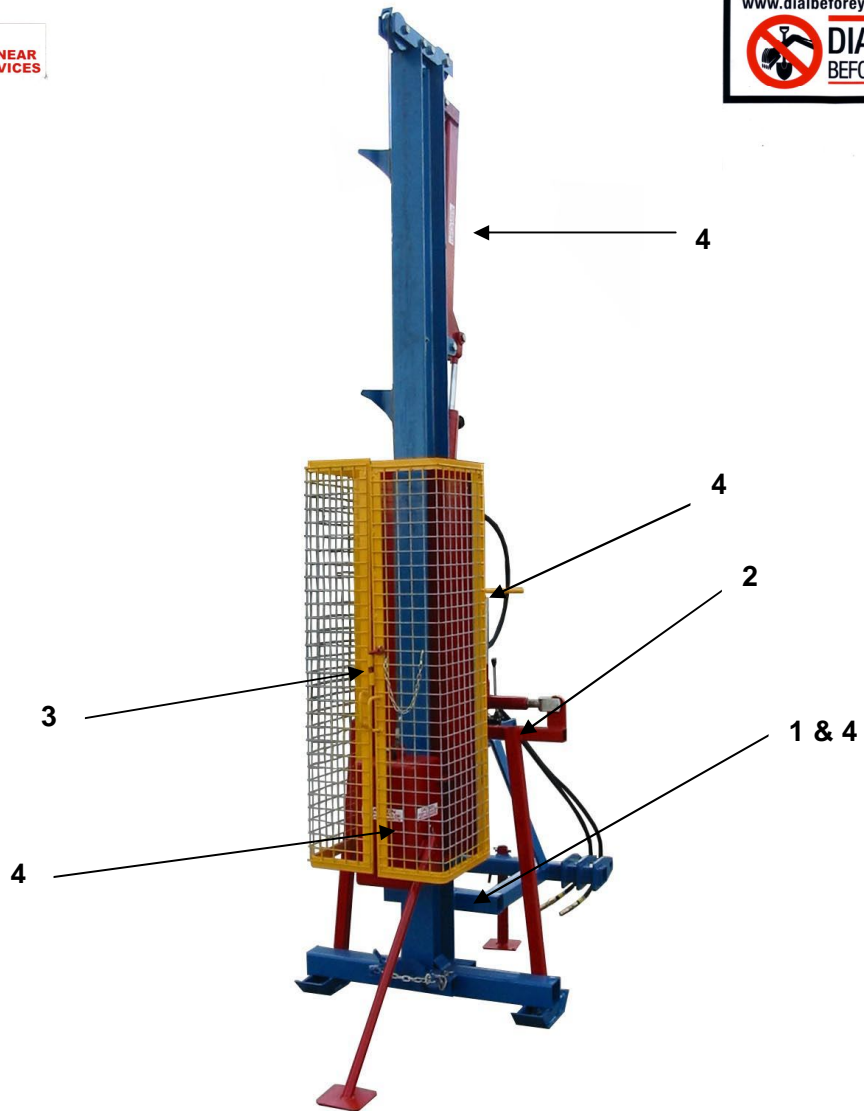
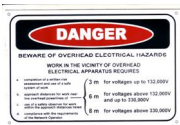

ASSEMBLY

Parts Checklist for hydraulics operation (inc electric solenoid system)

- Electrical Connections *(These components may already be assembled as one complete unit by the Berends)*
 - 1 x 710775 Black DIN Plug
 - 1 x OMRZ15GQB Plunger Limit Switch
 - 1 x OMRAP-Z Terminal Cover
 - 3 x Insulated terminals (blue)
 - 3 x 0.2mm insulated cable – 120mm, 1100mm and 4000mm long
 - 2 of 25x4mm bolt/nut
 - 1 of 35x12mm bolt
 - 2 of 12mm nuts
 - 1 x 7 pin trailer plug
 - 4 x cable ties (100x2.5mm)
 - Electrical Tape (optional)

- Solenoid Valve *(These components may already be assembled as one complete unit by the Berends)*
 - 1 x 02-161062 Poppet Valve
 - 1 x 02-160645 Aluminium Housing
 - 1 x 300AA00081A Coil
 - 2 of 3"x3/8" bolts
 - 2 of 3/8" nylock nuts

- Control Valve, Hose and Ram Kit
 - 1 x JB28 hose
 - 1 x JB29 hose
 - 1 x JB31 hose
 - 1 x JB32 hose
 - 1 x AM4000 Single Bank Control Valve
 - 1 x B2086-6 Plug with DS-6 seal
 - 2 x R81-08M male tips
 - 1 x 2 1/2" x 8" ram plus one clevis pin/clip
 - 1 x R62 Breather
 - 1 x S85-0614 adaptor
 - 1 of 5"x1" HT bolt
 - 1 of 1" nylock nut
 - 1 pair of control valve mounting plates (inc bolts/nuts/nylocks/sw)
 - 1 can of wire rope lubricant

Assembling Solenoid Valve

(If this component has already been pre-assembled go on to the next section)

- 1) Screw 02-161062 Poppet Valve into side port of 02-160645 Aluminium Housing (use the side port closest to Port 2) and tighten. (Figure 1)
- 2) Connect 300AA00081A Coil to the Poppet Valve and secure with nut. Ensure the 3 pins are facing upwards. (Figure 2)



Figure 1

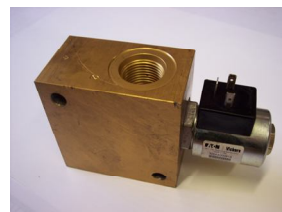

Figure 2

Assembling Electric Switches

(If this component has already been pre-assembled go on to (5))

- 1) Remove centre plug from plastic housing on the 710775 Black Din Plug. This is easily done by using the screw provided and pushing the plug out through the rear hole (Figure 3).
- 2) Take the 120mm piece of insulated cable and using 1.5mm wire strippers remove approximately 15mm of insulation from both wires at each end. Connect both wires from one end of this piece to No1 and 2 of the Plug and secure tightly (Figure 4). Slide the casing back over the plug from the other end of the wire.
- 3) Take the 1100mm piece of insulated cable and using 1.5mm wire strippers remove approximately 15mm of insulation from both wires at each end. Connect both wires from one end to the OMRZ15GQB Plunger Limit Switch using the Common (COM) and Nominally Open (NO) terminals. These are normally the middle terminal and the top one located closest to the plunger (Figure 5). You may need to shorten the wire connected to the middle terminal so that it looks uniform. Slide the OMRAP-Z Terminal cover over the limit switch with the opening at the opposite end to the plunger (Figure 6). Line the two holes up and secure with the 25 x 4mm bolt/nuts. Tighten the cord screw on the end of the cover all the way.

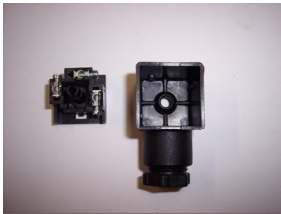

Figure 3



Figure 4



Figure 5



Figure 6

- 4) Take the 4000mm piece of insulated cable and using 1.5mm wire strippers remove approximately 15mm of insulation from both wires at each end. Using the blue terminals connect one wire from this 4000mm cable to one of the wires coming from the black DIN Plug. Connect the other wire from the 4000mm cable to one of the wires coming from the Limit Switch. Join the remaining two wires between the Limit Switch and the DIN Plug (Figure 7). When joining the wires with the terminals ensure that they are crimped securely. Wrap each terminal and the adjoining section of cable with good quality electrical tape to protect it from the elements.



Figure 7

(It is not important which specific wires you use, providing they form an electrical circuit from the power source (12 volt battery) through the DIN Plug, to the Limit Switch and back to the power source.)

- 5) Connect the remaining end of the cable to the appropriate coupling to suit your 12 volt power source. A 7 pin trailer plug has been provided however it may be necessary to purchase a different connection to suit your tractor. Wire the plug according to which function you wish to run the power through. A good example would be the park lights. (NB: Do not use the hazard lights)

Connecting the Hydraulics and Electrical Safety System to the Postdriver.

The post driver is usually transported from the manufacturer in the horizontal position.

Caution : Care must be taken when lifting the unit into the vertical operation position and must only be done on level, stable ground.

Prior to lifting (but whilst the unit is supported by a fork/crane/jib), remove the red T-piece bar bolted at the top end of the post driver. It is only used to protect the pulleys from damage when transporting the unit horizontally. Once the machine has been lifted vertically, keep the lifting apparatus in place whilst the post driver stands are re-positioned. This is best done after it has been lifted to prevent possible damage to these stands during lifting. There are two mounting stands, attached to the front (underneath the linkage) and the bottom (underneath the main upright) of the post driver. They will keep the post driver stable on a flat surface.

Do not climb on the unit at this point of time.

Before attaching to the tractor, ensure the post driver is standing secure on a flat surface and can not fall over. Line the lower linkage arms between the lower linkage plates of the post driver, slide the linkage pins through the holes and secure with linch pins. Attach the tractor top link to the post driver. Check that the lever arm can not come in contact with any part of the tractor when it is being lowered. Allow for the rear window on the cab and ensure it doesn't come in contact when opened. Once connected to the tractor, the two stands should be adjusted out of the way so that they don't interfere with the operation.

- 1) Connecting the ram - connect the ram and breather supplied as shown in Figure 8. A breather plug has been provided for the bottom fitting to prevent foreign matter being drawn in. The top end of the ram is fitted with a 5" x 1" high tensile bolt and locking nut to prevent wear on the ram clevis. The bottom end of the ram is supplied with a standard 1" clevis pin and clip. As the ram set-up is quite high, caution must be taken when connecting it. Ensure the person assembling this can not fall. If adequate safety measures are not available then the ram may be connected whilst the unit is horizontal (ie prior to lifting it up)

Figure 8. Hydraulic Ram set-up

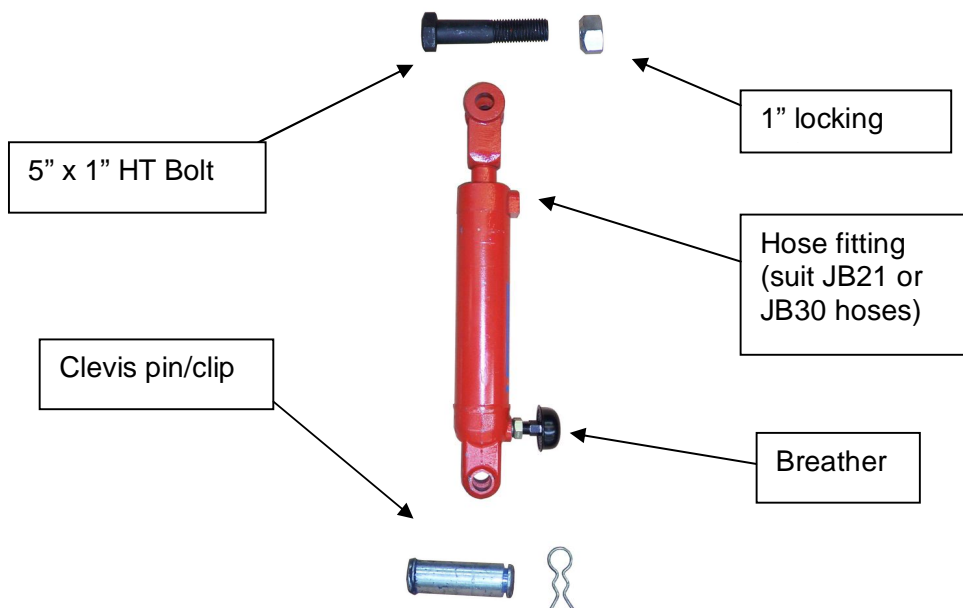

- 2) Connecting the solenoid valve – Before mounting the solenoid valve to the main beam, connect the 600mm hose (JB28) to port 2 of the solenoid valve and tighten. Connect the 800mm hose (JB29), with the elbow facing down, to port 1 of the solenoid valve and tighten. Bolt the housing to the main beam using the two 3" x 3/8" bolts and nylock nuts (Figure 9). Connect the 600mm hose (JB28) to the top port of the ram. The easiest way to do this is to connect the elbow separately before connecting the hose.



Figure 9

- 3) Hydraulic control valve (0270) mounted on unit – The following port markings refer to the diagram in Figure 10 and are not necessarily marked on the valve. Remove the S76-0812 elbow from the 1800mm hose (JB32) and connect it to port B of the AM4000 control valve with the elbow facing upwards. This must be done first as there is limited room to attach it once the valve is mounted to the frame. Mount the AM4000 control valve onto the main 100 x 50 RHS top frame (top link arm) of the post driver. Place the plates provided either side of the tube frame and with the valve sitting on top, secure with the two bolts provided with the threads facing down. Reconnect the JB32 hose to the elbow fitting previously attached at port B. Connect the JB29 hose (already attached to the solenoid valve above it) to port C. Connect the 1600mm hose (JB31) to port A. The last port is plugged using the B2086-6 plug and DS-6 seal. Finally, fit the male tips to the ends of JB31 and JB32. Ensure all fittings are tight so that oil leakage doesn't occur.

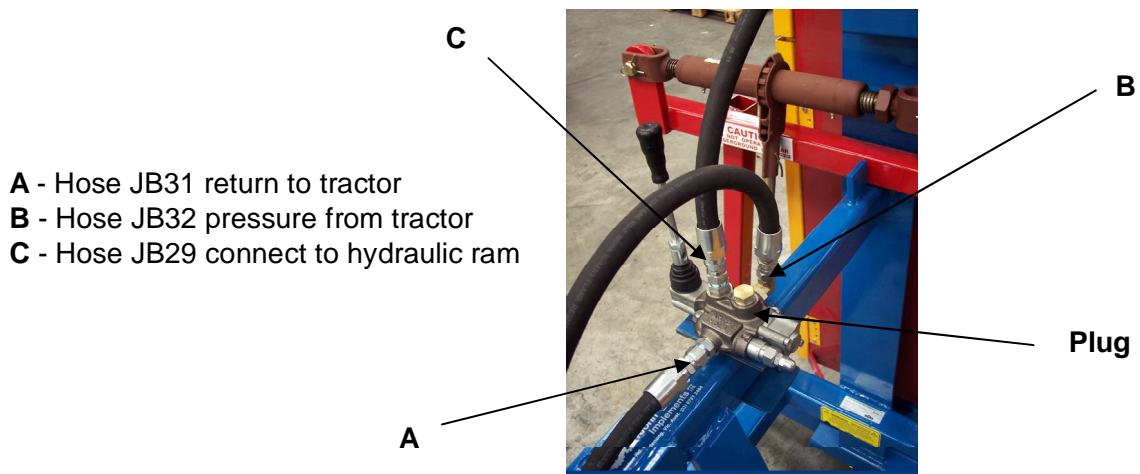

Figure 10. Hose position on hydraulic control valve

- 4) Connecting the limit switch to the 12 volt source – Screw the black Din Plug into the top of the solenoid valve (Figure 11). Attach the limit switch to angle bracket on the front of the nearest cage door. This is done by firstly removing the nuts on the limit switches plunger, inserting it into the hole on the angle bracket and secure with 2 nuts and one of the locking washers (Figure 12). On the adjoining bracket connect the 35 x 12 bolt and two nuts with the head facing the limit switch and a bolt positioned either side of the bracket. Adjust the nuts accordingly so that the bolt head completely compresses the limit switch when the gates are closed and securely pinned. When the switch is compressed

the limit switch is live, therefore allowing the solenoid valve to have 12 volt current and be operational. Cable tie the loose insulation cable back to the wire mesh so that it can't get caught on anything when the gates are opened (Figure 13). Connect the trailer plug to the tractor.



Figure 11

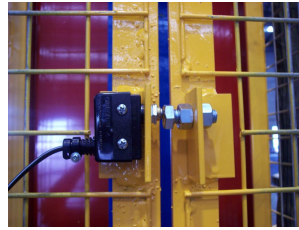

Figure 12



Figure 13

OPERATION

To operate the control valve the tractor hydraulics need to be positioned and locked in to constant pumping. If the tractor doesn't have a locking position, it may be necessary to tie down the tractor remote lever. If unsure about your tractors' hydraulics contact your dealer.

To test the unit is operational with the cage door closed, push the hydraulic control valve away from you when standing on the right hand side of the machine. Note: It may take a few seconds for the ram to fill up with oil and be fully functioning.

If there is no movement in the dolly, then either the hydraulics haven't been connected correctly, there is a bad connection in the 12 volt supply or the tractor hydraulics are not set-up to constant pumping. Recheck and try again. When the weight is operational then we know the solenoid valve is working safely. With the weight in its lowest position, open the cage doors and try operating the control valve again. As the 12 volt supply is now broken, the hydraulics should cease working. It is now ready to operate.

Once all safety procedures have been followed, start the tractor and raise the post driver off the ground.

Transporting

When transporting the post driver along a public road, ensure all road regulations are adhered to. In particular, be aware of height restrictions in regards to bridges and overhead power lines. Always travel with the hammer (dolly) in the lowest position.

Don't travel too quickly so that the postdriver or the hammer are "jumping" up and down as this will place undue stress on the wire cable. Be particularly careful, when crossing rough or uneven terrain.

Setting up

Caution : Do not drive posts until it has been determined that there are no underground services such as gas, electricity or water in the vicinity.

Position the post driver at the point where the post is to be placed and lower the machine fully onto the ground. Ensure the mast or main beam is vertical by adjusting the ratchet tilt link or the tractor top link. There are two level guides on the main beam to help judge how straight the post is.

At this point keep the safety cage closed. Use the remote hydraulics or control valve to raise the main weight until it is above the height of the post. Open the cage doors. Place the post vertically against the main beam and secure the post using the sliding clamp and chain. The clamp is best situated near the top of the post (NB. Over time you may need to apply some grease on the post side of the main beam so that the clamp slides easily). Additional sliding clamps can be purchased if more than one is required to hold the post. Alternatively optional post caps be used which slide over the top of the post and hold it in place this way. They also minimise damage caused to the top of post by the hammer dropping. Close the two cage doors and secure with the pin provided. The post driver is now ready to operate.

Caution : When the cage door is open, ensure no-one operates the hydraulic controls. Do not allow any person to climb into the cage during operation.

Driving posts

Caution : Post drivers can be noisy and may eject pieces of wood. The design of the cage has been designed to minimise this, however as a safety precaution, it is advised that the appropriate eye and ear protection is worn.

All hydraulic operations must be operated from the control valve on the unit. Release the ram so that the weight is allowed to fall. When the weight comes to a stop, use the hydraulic valve to lift the weight almost to the top of the main beam. The thimble eyes on the wire rope should not come in contact with the top plate on the pulley system. This may take some initial practice with the remote hydraulics. If you let go of the lever, the hydraulics go to the neutral position and will stop. Stop the hydraulics before releasing the weight again. If you only need to knock the post a short distance (usually towards the end of the operation), the weight only needs to be lifted part way up the mast. This will reduce the impact and ramming effect. Alternatively, the hydraulics can be slowed down in both directions by only applying a small amount of pressure to the control lever. This reduces the oil flow and is handy when lifting the hammer up, particularly as it gets closer to the top of the mast.

Caution : Do not change direction of the weight via the hydraulics until the weight has come to a stop. Failure to do so will apply unnecessary pressure on the wire cable and the hydraulic ram.

Cage Doors

The cage doors are split into a lower and upper section. They should be kept bolted together at all times unless the situation occurs where a post needs to be placed in an existing fenceline. In this situation only, the two lower gates can be unbolted and left open during operation. The two upper gates will still be connected to the solenoid valve and will function as normal. That is the weight can't be lowered unless the upper gates are closed.

Operating under these circumstances should be minimised as it allows a small section of the weight to not be guarded. This section is 1.2m from the ground which is approximately the same height as standard fence posts once they have been driven. Therefore the weight will still continue to be guarded under this circumstance. It is important that the lower guards be bolted back into position once this application is no longer required.

Caution : At no stage should anyone approach the weight/post whilst the lower cage is opened and the top cage is closed. Always open the top cage if there is a requirement to access the post. Ensure there are no bystanders present when operating the driver in this mode.

Stopping

Lower the post driver, stop the tractor engine (removing the ignition key) and apply the park brake. Ensure that the post driver is well supported when not in use. Ideally, the unit should be stored undercover to reduce the exposure of the wiring to the elements which can deteriorate over time if exposed. Always have it supported on a hard flat surface, preferably concrete, with both the front and rear support stands fitted before it is removed from the tractor. The hammer must be in the lowest position when storing the post driver.

MAINTENANCE

When doing any type of maintenance on this machine, always follow the safety steps described in this manual. Use only authorised genuine parts for replacement. The post driver must be adequately supported (Make certain it cannot fall).

Solenoid Valve

Do regular inspection tests on the solenoid valve. Ensure no other persons are in the vicinity of the post driver. With the cage doors closed ensure that the hydraulic valve freely moves the dolly weight up and down. Now with the weight in the lowest position, open the cage doors and try to operate the hydraulic valve. If the hydraulic valve doesn't work under these circumstances then the solenoid valve is working. If it does continue to operate then cease operating as there is a problem with the limit switch system. Under these circumstances contact a qualified person.

Hydraulic Fittings and Hoses

Before doing any maintenance on the hydraulic system, release the oil pressure. Be careful when searching for oil leaks as oil escaping under pressure can be invisible and may penetrate the skin. All hydraulics hoses have a minimum burst pressure of 20,000psi and a maximum working pressure of 5000 psi (4:1 safety factor)

If leaving the grader blade outside for an extended time it is advisable that the chrome cylinder rods be lubricated with an appropriate lubricant to prevent corrosion.

Clean all dirt and foreign matter away from the rods prior to using so that seals do not become contaminated.

Cable

Check cable regularly for any wear. Replace cable immediately if wire is frayed. Wire rope lubricant has been supplied with this unit to extend the life of the cable. The cable may become slightly stretched over time, particularly if incorrectly used. This may affect how high the dolly weight lifts up. There is some adjustment available where the cable is connected to the main mast. By positioning the cable in a higher hole, this will reduce the lifting height of the weight. Only replace cables with a genuine Berends cable which comply with Australian Standard AS1666.1-1995

Lubrication

Keep the tilt ratchet adequately lubricated with grease (two grease points). The main arm also has two grease nipples which must be kept lubricated. Ensure the bronze bush on the main arm is not worn and replace if necessary. There is also a grease point on the main beam where the ram is connected.

SPARE PARTS

ORDER SPARE PARTS THROUGH YOUR ORIGINAL SUPPLIER OR YOUR LOCAL JOHN BERENDS IMPLEMENTS DEALER.

Always quote the machine serial number or product number, spare part number and its part name as stated in the operator's manual.

Post Drivers

Key No.	Part No.	Quantity	Description
1	2010	1	Cable
2	2011	3	Pulley (inc. bearing)
3	3693	1	Ram suit main operation (and optional tilt function)
4	2324	1	Ram Breather (inc. adaptor)
5	2325	1	Hydraulic hose (JB21) – ram direct to tractor
	2326	1	Hydraulic hose (JB30) – suits optional control valve
	2327	1	Hydraulic hose (JB31) – suits optional control valve
	2328	1	Hydraulic hose (JB32) – suits optional control valve
6	2329	1	Hydraulic control valve (no hoses)
7	3210	1	Tilt ratchet
8	2330	2	Dual Cat linkage pins
9	2331	1	Main arm (less pulley)
10	2332	1	Door spring
11	2333	1	Front stand
12	2334	1	Rear stand

