

# FENDT

## Fendt 700 Vario

714 • 716 • 718 • 720 • 722 • 724



## The new Fendt 700 Vario

# The perfectionist.

Just being good is not enough. The perfect coordination of the tractor and operator is what produces successful results. To make your daily work a thing of perfection, we have brought together all of the best solutions in the new Fendt 700 Vario to build a perfected unit of power and manoeuvrability, precision, reliability, functionality and comfort. The most popular high-horsepower tractor, ranging from 145 – 240 hp, is your strong partner for all operations – from light-duty grassland operations, over dynamic transport, to heavy-duty field operations.

Become a perfectionist. With the Fendt 700 Vario.

714 Vario	145 hp	107 kW
716 Vario	165 hp	121 kW
718 Vario	180 hp	132 kW
720 Vario	200 hp	147 kW
722 Vario	220 hp	162 kW
724 Vario	240 hp	176 kW

Maximum output to ECE R24





The new Fendt 700 Vario

## Perfected for every application

The Fendt 700 unites function and efficiency. The new 4-speed rear PTO enhances versatility, while reducing fuel consumption. With the additional 1000E PTO speed, you can save fuel with a reduced engine speed – even for implements with a high speed demand, such as a rotary harrow, slurry pump, hay rake or manure spreader. Thanks to SCR technology with passive CSF and exhaust gas recirculation, the Fendt 700 Vario complies with emissions standard EU Stage 4 / Tier 4 final and achieves high overall efficiency.



The right speed for every operation: With the additional PTO speed 1000 E, you can work at a reduced engine speed and save fuel effectively.





## Fendt 700 Vario Power

### Perfect for all operations

The Fendt 700 Vario offers the right features for the requirements. Choose the best solution for your needs from the equipment variants Power, Profi or ProfiPlus. The 700 Vario Power offers a number of features that will make your everyday work easier. Equipped with a fourth PTO speed, 1000E, you save fuel when working with high speed requirements. The load relief control for the comfort front linkage moves the weight from the implement to the tractor and offers better traction, perfect ground hugging and more uniform

implement guidance. Thanks to the new front axle suspension with a 100-mm suspension travel, the chassis provides maximum comfort and stability as well as exceptional transmission of pulling power. You can control the entire tractor using the clearly laid out Varioterminal 7" with touch and key operation.



### More power



- Higher lift capacity of 10,360 daN
- 14 t perm. overall weight, 6,020 kg payload
- Comfort front linkage with load relief control
- Hydraulic system with load-sensing pump with 109 l/min as standard specification, 152 l/min as optional

### More functions



- 4-speed rear PTO 1000E for lowering the engine speed and saving fuel
- Varioterminal 7" with touch and key operation
- Leakage oil container integrated in rear and front linkage

### More profitability



- Emissions standard EURO Stage 4 / Tier 4 final
- Automatically drives in the most economical range with the TMS tractor management system
- Passive diesel particulate filter CSF (Coated Soot Filter)

## Fendt 700 Vario Profi and ProfiPlus

### Functionally perfect

The Fendt 700 Vario offers additional solutions in the Profi and ProfiPlus equipment levels that provide extra comfort and functionality for demanding working requirements. In combination with the Varioterminal 10.4-B, you get next-generation controls. The terminal convinces through its modern design, intuitive menu navigation and innovative solutions for the perfect coordination of all tractor and implement functions.

Not only the interior of the Fendt 700 Vario Profi and ProfiPlus boasts high-grade equipment, the exterior shines, too. The bright and economical LED lighting illuminates the surroundings in all directions.



### More power



- Hydraulic system with load-sensing pump with 152 l/min (standard) and optional with 193 l/min for more hydraulic power
- Automatic trailer steering axle lock

### More functions



- 300° wiper for a larger wiper field
- LED headlamps with headlamp levelling
- New LCD Varioterminal 10.4-B in smartphone look and terminal bracket with ball joint

### More profitability

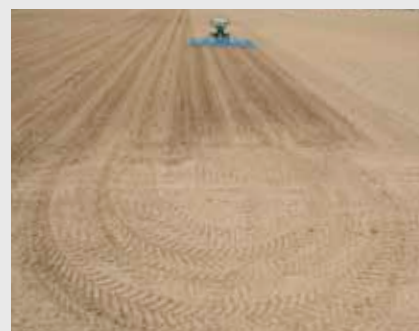

- Electric hydraulic filter monitoring (service intervals 2,000 hrs)
- VarioGuide (ProfiPlus) automated steering system and VarioGuide light (Profi) possible. VarioGuide reduces overlapping and saves fuel, working time and operating materials

## Fendt Spotlights. Our special solutions.

### A holistic approach.

The perfect tractor is more than just the sum of its parts. It is the perfect interplay of all the components that complement each other for an optimal result. That is what makes a tractor a Fendt.

### Notably Fendt. Simply better in detail.

We have an eye on the whole. And optimise every detail for it. We develop solutions that make sure you can make more happen – easier, faster and simpler.

Look for the Fendt Spotlights! They show you what makes a Fendt special.

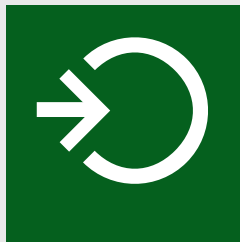

Fendt Spotlights: This icon stands for notable solutions from Fendt. Solutions that help you every day, which we will explain to you in further detail.



Fendt Spotlights – exceptional solutions that illuminate the special features of a Fendt.

#### VisioPlus cab

➔ Perfect view with 300 degree wiper for the panoramic windscreen

➔ High-grade LCD Varioterminal 10.4-B with touch and key operation in smartphone look, ball joint enables ideal adjustment

#### Engine and transmission

➔ Passive diesel particulate filter CSF (Coated Soot Filter): maintenance-free, saves fuel

➔ Four-speed rear PTO with the speeds 540, 540E, 1000 and 1000E

#### Vehicle body

➔ Two cruise control speeds can be directly selected on the joystick

➔ 14-tonne permissible overall weight with a high payload of 6,020 kg

➔ VarioActive superimposed steering system for fewer turns of the steering wheel, e.g. at the headlands

#### Mounting areas

➔ High-performance hydraulic system with load-sensing pump with a delivery capacity of 109 l/min, 152 l/min, or 193 l/min, depending on the equipment variant

➔ The DCUP couplings permit the hydraulic valves to be coupled under pressure without risk of contamination, as well as easy and fast mounting and removing of implements.



## Fendt 700 Vario. The perfectionist.

### VisioPlus cab

starting on page 22

### Variotronic

starting on page 28

### Engine and transmission

starting on page 14



### Mounting areas

starting on page 34

### Vehicle body

starting on page 18



## Perfect coordination

The engine and transmission of the Fendt 700 Vario form a perfect unit for a high-torque drive train with stepless driving pleasure. The tried and proven, powerful six-cylinder engine in the Fendt 700 Vario convinces through lively handling with high manoeuvrability and a maximum output of up to 240 hp. The new engine components increase durability and reduce fuel consumption. The further developed SCR exhaust technology complies with the requirements of emissions Stage 4 / Tier 4 final.

## Perfect coordination for the best drive train

### Power and reliability

The tried and proven six-cylinder Deutz engine on Fendt 700 Vario delivers 145 to 240 hp with a top speed of 50 km/h. With a 6.1 litre cubic capacity, 4 valves per cylinder and common rail injections, the engine offers a high torque driving experience. The compact high-horsepower tractor is designed for maximum performance and load capacity. The engine and transmission are ideally coordinated, so that a high overall efficiency can be achieved.

### Economical and environmentally friendly

Every litre counts. The Fendt 700 Vario is equipped with the SCR exhaust technology and is especially fuel-efficient and complies with the emissions standard EURO Stage 4 / Tier 4 final. The passive diesel particulate filter, which does not require additional injection of fuel into the exhaust line, also saves fuel. With perfect engine and transmission coordination, the new Fendt 700 Vario delivers full performance in the field and on the road.

#### Engine characteristics – Fendt 724 Vario

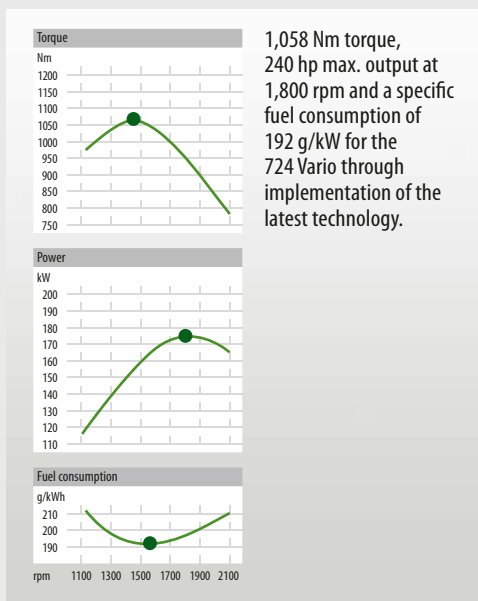

Maximum engine efficiencies are achieved through ideally coordinated components: Exhaust turbocharger with wastegate, fuel pre-filter with thermostatic valve and air intake via a bonnet, which provides for a high air flow without requiring an intake pipe on the cab pillar.

The fuel and AdBlue consumption indicator not only monitors the current consumption, but also logs the consumption for different operations. Furthermore, it assists the operator in maintaining an efficient driving style.



The fuel pre-filter with thermostatic valve allows the tractor to start reliably, even at temperatures well below zero, since the pre-warmed fuel flows from the return into the prefilter. The radiator and filter are arranged for ease of maintenance.

#### Exhaust gas after-treatment



#### SCR (Selective Catalytic Reduction) for exhaust gas after-treatment

With SCR technology, exhaust is after-treated with AdBlue®, a 32.5 percent solution of urea, which converts nitrous oxides  $\text{NO}_x$  into non-toxic nitrogen and water.

#### AGReX external exhaust gas recirculation



The external exhaust gas recirculation ensures that the nitrogen oxides  $\text{NO}_x$  are already reduced before they reach the exhaust line. That is more economical, because less AdBlue is required in the exhaust line to further reduce the nitrogen oxides.

#### Diesel particulate filter Coated Soot Filter (CSF)



The passive coated soot filter is regenerated while driving and does not need to be actively started. No additional fuel is required for regeneration. The coated soot filters in Fendt tractors are designed for a long life, replacement is not necessary.

### Perfect driving is stepless.

Because only with the stepless Fendt Vario transmission can you drive at the ideal speed for your work. You can drive from 0.02 km/h to a maximum speed of 50 km/h, exactly, without steps. And you can operate your tractor conveniently with the multifunction joystick. Reduced maintenance costs through longer transmission oil change intervals, every 2,000 hours, have an especially positive impact.

### Go to the limit with full power

Features, such as the automatic maximum output control 2.0, further reduce fuel consumption, since the engine is always running in the ideal speed range. The load limit, which is different for each operation, is regulated automatically. The limit no longer needs to be entered manually and the engine and transmission are always perfectly coordinated. In kick-down mode, the tractor accelerates swiftly and convinces through lively handling.

#### Fendt Vario transmission

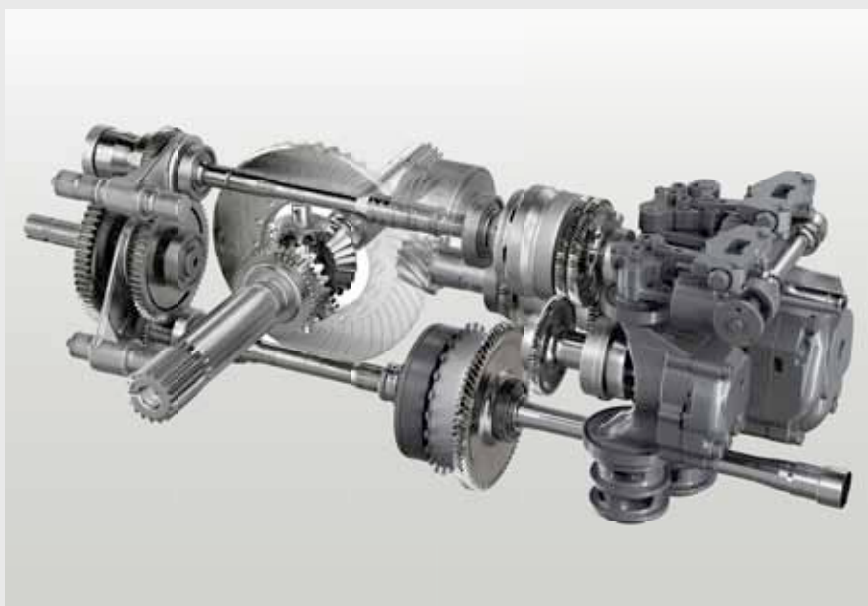

The Fendt Vario transmission is a hydrostatic-mechanical power split drive. With increasing speed, the share of the mechanical power transmitted through the planetary set increases. The hydrostats can be swung 45 degrees and have a high operating pressure of max. 550 bar – this ensures exceptional efficiency.

#### Joystick / Pedal



➡ The driving mode can be selected individually: The speed can be controlled with either the pedal or the joystick.

#### Easy access



➡ The engine compartment is easy to access, even when the front loader mounting parts are attached. The one-piece bonnet with two separate side panels can be opened without tools.

#### TMS / max. output control 2.0



Thanks to the TMS tractor management system and the automatic maximum output control 2.0, the tractor automatically adjusts the engine speed.

### The most modern engine and transmission technology

- Six-cylinder engine with 6.06 l cubic capacity and common rail injection: 240 hp maximum output at 1,800 rpm
- SCR technology for compliance with emissions standard EURO Stage 3b / Tier 4 final and excellent fuel efficiency
- Vario transmission for stepless driving from 0.02 to 50 km/h
- Tractor Management System TMS and automatic maximum output control 2.0 are standard
- Optimum weight-power ratio of 33 kg/hp (724 Vario)
- Lockable engine bonnet
- Fuel prefilter with thermostatic bypass valve



## Trust begins at the base

Ready for every operation: The Fendt 700 Vario meets all your requirements for robustness and reliability. The strong cast half-frame with self-levelling front axle easily masters high payloads over six tonnes. The integral compressed air braking system keeps the tractor and trailer safe when braking and the cast half-frame enables stable handling in curves, even at high speeds. With the perfectionist, your work day begins with a good feeling.



## Many paths – one goal: arrive quickly and safely

### The points for performance and comfort

The entire chassis of the Fendt 700 Vario has been perfectly designed for demanding operations and fast transport.

- Self-levelling front axle suspension with 100 mm suspension travel
- Pneumatic dual-circuit braking system with one-pedal or steering clutch brake
- TMS pedal mode with adjustment of deceleration through thrust detection
- Automatic trailer steering axle lock
- 100% differential locks for front and rear

### Fast transport and high payload

A robust cast half frame, which enables a permissible gross weight of 14 tons, carries the load on the Fendt 700 Vario. With a high payload of 6,020 kg, the compact high-horsepower tractor has plenty of reserves for heavy implements. The self-levelling front axle suspension has a 100-mm suspension travel for optimum play. It provides comfort and safety with an especially direct transmission of pulling power, even with heavy loads.

### Comfort and safety



The design of the suspension on the 700 Vario enables maximum ride comfort in the field and on the road. The combination of front axle suspension, cab suspension and seat suspension, which provides a driving sensation on par with passenger cars, was adopted from the high-horsepower tractors.

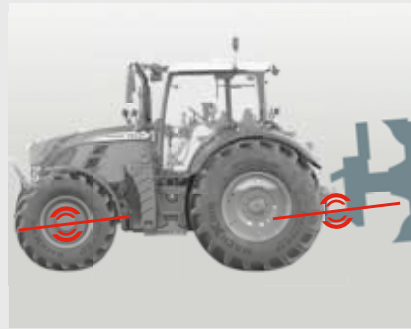

Shock load stabilising prevents the tractor and implement from bouncing by actively counteracting movements using the hydraulics. It reduces pitching movements so you benefit from improved steering safety and higher ride comfort.

Without VarioActive  
1 turn = 26.6°

With VarioActive  
1 turn = 43.3°

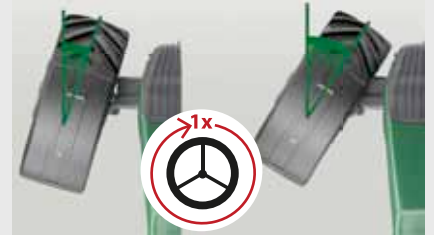

In relation to the standard setting, with VarioActive one only needs approx. 60% fewer turns of the steering wheel for the same wheel angle. With VarioActive, you profit through the faster reaction of the steering during tight turning manoeuvres at the headlands or during front loader work. For reasons of safety, it can only be used from 0 – 25 km/h.

### Front axle suspension standard specification



The front axle, which has a suspension system as standard, enables high payloads along with the best ride comfort. The +/- 50 mm suspension travel, absorbs uneven surfaces very well. The swing angle of 8° ensures stability while driving. The 52° steering angle on the front axle guarantees maximum manoeuvrability.

### Clever controls



The lighting is easily set and adjusted thanks to its straightforward layout. With the smart one-button system, all previously set work lights can be switched on and off easily and quickly with just one touch of a button in the membrane keypad.



### Safe braking

High transport loads must be slowed down quickly in hazardous situations. The pneumatic dual-circuit braking system decelerates the tractor very effectively. The compressed air based braking system reacts very sensitively and precisely. The one-pedal brake has proven to be especially advantageous during transport with trailers. The TMS Tractor Management System increases driving stability through automatic thrust detection and intelligent deceleration.

### Absolutely stable

The Fendt Reaction steering system guarantees optimal straight-ahead driving. After negotiating a curve, it returns the steering wheel back to its starting position faster. The automatic steering axle lock ensures stable straight-ahead driving with trailers. Starting at specific speeds, or when reversing, the self-steering axle is automatically locked without requiring driver intervention.

### Powerful lighting concept



The ingenious lighting concept on the 700 Vario doesn't leave you in the dark. The work lights on the 700 Vario can be individually adjusted for up to 360 degrees of illumination. Optionally available as LED lights.



With the corner lights, you have the entire wheel arch in view, even at night. The corner lights are also available as extra bright LED lights.



The arrangement of the lights in the 700 Vario is unique – the work lights are "cross-eyed". This prevents all shadows and reflections so operators profit from an optimally illuminated field of vision.



Finish your work safely: The integrated coming home light permits operators to climb down from the tractor safely, even in the dark. The headlights continue to shine a while longer after the tractor is switched off.

### Driving dynamics with safety and comfort

- Permissible overall weight of up to 14 tonnes
- High payload of up to 6,020 kg
- Self-levelling front axle suspension with 100 mm suspension travel
- Automatic trailer steering axle lock
- Rear and front differential with 100% disc locking
- Dual-circuit braking system
- Brake light is actuated when decelerating as early warning for traffic following tractor





The Fendt VisioPlus cab

## Comfort at its peak

You are connected directly to the ground through your tractor. The steering wheel, driver seat, suspension and operating elements are finely tuned to each other and are constantly giving you feedback. To allow you to maintain constant control, we have developed the perfect solution: the VisioPlus cab. Comfortable entry, optimal suspension, ergonomic arrangement of the operating elements as well as more visibility and space with panoramic front window, 300-degree wiper, LED lighting concept, and much more.

## Best visibility from inside – a beautiful sight from outside

### Everything in view

The panoramic windscreen on the VisioPlus cab curves up into the roof and opens the view upwards and downwards. With a 77-degree angle, you have your work in full view, even when the front loader is raised. The large 6.2-m<sup>2</sup> glazed area provides a perfect all-round view without a B-pillar to get in the way. Rain won't stop you: with a 300-degree wiper field, the wipers provide a clear view over the complete front.

Electrically adjustable external rearview mirror with wide-angle mirror expands your view towards the rear. Fogged mirrors are a thing of the past: heated rearview and wide-angle mirrors keep the view towards the rear free in the winter.



### Sight angle



Panoramic windscreen with 77° sight angle for a full view upwards and to the wheel arches.

### Elimination of B-pillar



One-piece side window and unobstructed all-round visibility without a B-pillar to get in the way.

### Wide-angle mirror

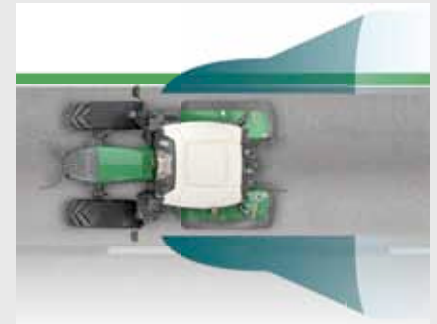

The wide-angle mirror is integrated on the main mirror as secondary mirror and expands the field of view considerably.

### Everything in the right light

In the Fendt 700 Vario, you also work safely and effectively in the dark. The lighting on the Fendt 700 Vario is so precise, inside and outside, that everything is very well illuminated 360 degrees around the tractor. The lights on the steps to the cab already provide safety and a sure feeling. Equipped with high-quality LED headlamps, night becomes day. Dipped and main lights in the bi-LED headlamps offer a wide view as well as increased safety on the road. They have especially strong illuminating power with low power consumption and a long lifetime. All

previously selected work lights can be switched together centrally with just one button. The ambient lights provide pleasant interior lighting. After a full day of work, the intelligent coming home light illuminates your way home.

#### LED headlamps with headlamp levelling



 The LED headlights provide an especially wide and bright light. Furthermore, they save power and have a long lifetime. The light range can be adapted to the situation at hand, for example for driving on the road.

### The Fendt VisioPlus cab

- Large cab with a 2,520-litre volume for an exceptional sense of space
- Curved, one-piece panoramic windscreen with a 77° field of vision for an unobstructed view upwards
- 300° wiper for a large, clear wiper field
- Narrow, compact bonnet for best all-round visibility
- Heated rear window
- Illuminated control console on the right armrest
- Automatic dimming of the interior lighting
- Daylight lighting with LED work lights for the front and rear
- Crossed light beams for optimal illumination in the front

## Because cabs are more than just a workplace

### Overview and comfort

The Fendt VisioPlus cab offers plenty of space for your comfort. This already starts when you climb up into the cab on the wide step treads. With more than six square metres of glazing, the cab is not only a visibility wonder – you also have a greater sense of space thanks to the 2520-litre air space and the well thought-out ergonomic arrangement of all the components. Numerous storage spaces provide practical stowing options.

### High-grade equipment

The high season can come: The Fendt 700 Vario has pneumatic cab suspension for perfect ride comfort. The three-point pneumatic cab suspension compensates perfectly for uneven terrain. You sit very comfortably and relaxed on the "Evolution dynamic" super comfort seat, which provides ideal support to the lumbar region. Suspended with compressed air from the vehicle compressor, the seat adapts itself to your weight. The comfort instructor seat features an integral writing table. The height and tilt-adjustable steering column can be quickly adjusted with the foot pedal to provide



**Driver and instructor seat**



The suspension system and the individual armrest adjustment ensure comfortable work days. In addition to the standard specification comfort seat with air suspension, an optional super comfort seat with seat heater and pneumatic lumbar support is also available.

**Pneumatic cab suspension**



The pneumatic cab suspension reduces vibrations effectively and provides high ride comfort. It is supported on four points with integrated self-levelling: the cab rests on two conic bearings at the front and on two air spring elements at the rear.

**Pneumatic comfort cab suspension**



The pneumatic cab suspension with braking and pitch compensation reduces vibrations to a minimum and provides high ride comfort. It is supported on three points and has an integrated self-levelling feature. Pneumatic comfort cab suspension is not available for the Fendt 700 Vario Power equipment variant.

the perfect sitting position. A radio with CD and MP3 function and four stereo loudspeakers deliver the best sound quality in the cab. The bearings in VisioPlus cab have been optimised to absorb unpleasant noises from outside. Automatic climate control provides ideal ventilation and ensures the temperature is perfect in the cab. The toxic filter ensures the best breathing air, even during dusty operations.

#### Integral cable lead-through



 Cables can be led into the cab from the outside, neatly and through the closed rear window. The cable lead-through protects the inside of the cab against dirt, water and noise.

#### Roof hatch



The hatch integrated in the roof liner offers additional ventilation on hot days. The roof houses the radio, the controls for the air-conditioning and a bay for a tachograph. An auxiliary device holder, e.g. for additional terminals, is mounted on the right-hand side.

#### Automatic climate control & lighting



All lights are assigned to illuminated keys on the control console and can be actuated with a click. The integrated air conditioning ensures optimal cooling and comfort – manually controlled in the Power variant, fully automatic control in the Fendt 700 Vario Profi and ProfiPlus.

#### Clamp holder



Clamp holder for storing documents securely.

#### Steering wheel position



For an optimal sitting position, the steering wheel must be at the right height and tilt angle. The cockpit, including the steering wheel, is individually height-adjustable.

#### Cooling compartment



You surely would not want to do without the comfort of a cooling compartment for drinks. On hot days, cool refreshments are always well within reach behind the passenger seat.

## Operate efficiently – drive comfortably

### Electronic assistants

As part of the across-brand AGCO Fuse strategy, the Fendt Variotronic includes electronic automated functions and solutions for individual settings, which make work simpler, faster, more precise and more efficient. Special, innovative solutions permit seamless integration and connection of the entire fleet.

### Perfectly controlled

Operating the Fendt 700 Vario Power is straightforward and easy using the fully integrated Variocentre. The ergonomic arrangement and colour coding of the operating elements corresponds to the current Fendt tractors and guarantees across-range, fast and practical operation. The integrated Vario TMS (Tractor Management System) ensures optimal coordination of the engine and transmission. The result is maximum ride comfort and absolute fuel-efficiency.



The Fendt Variotronic includes and integrates the key functions for higher efficiency.  
 Unique: All functions can be adjusted easily and conveniently with the Varioterminal.  
 The main applications are: • Variotronic implement control ISOBUS • VarioGuide automated steering • VarioDoc documentation

#### AgCommand™

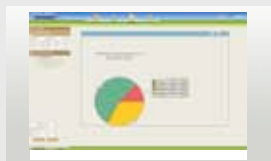

The analysis capability of AgCommand™ permits operations to be optimised effectively through near real-time data transfer.

#### Variotronic™ automatic



Fendt Variotronic™ activates the operating sequence fully automatically at the headland line. That saves time through faster turns.

#### VarioGuide



VarioGuide provides highly precise guidance with an accuracy of up to  $\pm 2$  cm and increases the economy of all operations.

#### SectionControl



The new SectionControl function enables fully automatic section control via GPS signal, dependent on the desired degree of overlapping.



## Being perfect can be so easy – Fendt 700 Vario Power

### Firmly under control

With the multifunction joystick, you can control the tractor easily and precisely. The 4-way multi-function joystick accelerates and decelerates the Fendt 700 Vario without steps. The joystick lies well in the hand and numerous features can be activated directly on the lever: cruise control, speed memory, the hydraulics and additional automated functions, such as the headland management. The valves can be actuated directly from the joystick and freely assigned in the Varioterminal.

### Headland turns made easy: Fendt Variotronic™

Electronic assistance is a real benefit, especially for headland management. With our Variotronic™ you save up to 1,920 hand movements in 160 turns. You can program up to 20 settings into the terminal for the turning manoeuvre, both when stationary and when driving. Later all it takes is a touch of a button to activate the automated procedures at the headland. You can drive without having to reposition your hand.

### Straightforward operation on the multifunction armrest

4-way multi-function joystick with additional operating buttons for the 3rd and 4th auxiliary hydraulic control unit and Variotronic™ headland management

Varioterminal 7"

Power lift control module (EPC) for rear linkage includes a quick lift switch, depth control and PTO actuation (optional for front linkage)

Control panel with membrane keypad for transmission, hydraulic and PTO functions. TMS activation, speed range selection, 4WD and differential lock engagement, front axle suspension, PTO speed selection

Cruise control buttons

Engine speed memory keys

Crossgate lever for the 1st and 2nd auxiliary hydraulic control units



 You can operate and monitor all the functions of the Fendt 700 Vario Power in the terminal. Simply touch the corresponding menu item directly on the touchscreen or click a key. With 262,000 colours and a clear resolution of 480 x 800 pixels, all content can be recognised quickly and easily. The display dims automatically at night, without blinding.

## Provides an overview: Fendt 700 Vario Profi/ProfiPlus

### Centrally controlled

The Varioterminal is the central control unit for all tractor and implement settings. Furthermore, you can operate and keep track of the Variotronic features directly in the terminal. The components in the Varioterminal meet the highest demands for quality, reliability and the best workmanship. ISOBUS-capable implements can also be controlled directly with the Varioterminal. No additional implement terminals are necessary, so you gain more space in the cab and have a better overview.

### The newest generation Varioterminal

The Varioterminal 10.4-B on the new Fendt 700 Vario sets standards for modern touch control. The borderless LCD display with a full glass front is the central control element and a real eye-catcher with its smartphone look. The high-grade touch display made of scratch-proof glass has a resolution of 800 x 600 pixels and 16 million colours for crisp images. Touch operation reacts sensitively and quickly. Key operation is also available.



### Precise application

The implement control features automatic SectionControl. SectionControl switches sections on and off at the headlands or in the field and at the edge of the field, to prevent overlapping. When working with sprayers, fertiliser spreaders, precision air seeders and seed drills, SectionControl provides further savings potential for inputs.

### Drive once, use forever

Transferring your field settings to other tractors is child's play. The Varioterminal saves your field and implement settings, such as waylines, obstacles, field boundaries, worked area or markers. This data can easily be saved to a USB stick and imported to the Varioterminal of other tractors. The data can be saved on the PC and checked with a map view.

#### SectionControl



 The fully automatic section control integrated in the Variotronic operating interface uses GPS and is dependent on the desired degree of overlapping. Up to 24 sections can be set when using ISOBUS-capable sprayers, fertiliser spreaders and seed drills. This results in precise work results and saves seeds, fertiliser or pesticides by preventing double applications or treatments of areas outside of the field. And it makes work easier for operators, day and night.

#### USB ports



The field settings can be transferred to other Fendt tractors using the USB port. Additionally, the port can also be used to charge mobile phones.

#### Headland management



With Variotronic<sup>®</sup> headland management, operators can create and save operating sequences while driving or standing still. More than 20 steps can be programmed in the sequence.

#### Variotronic implement control ISOBUS



 The functions for the Variotronic implement control ISOBUS and headland management can be assigned to the multifunction joystick as desired, if the implement supports this feature. Operators can find the perfect operating ergonomics for the operation at hand.

## Who has the most beautiful track of all?

### Always on the right track

VarioGuide permits the highest utilisation of your machines, since you can work very accurately, even at night, under poor visibility conditions or with large working widths – because the tractor automatically drives a perfect line. Overlapping is reduced and, depending on the working procedure, savings of three to ten percent can be achieved. Depending on the requirements of your operations, you can choose a system with an accuracy of up to +/- 2 cm.

### VarioGuide light – the simple guidance system

VarioGuide light is the economical solution for dairy farms, mixed farms or market fruit farms, which are looking for a cost-effective guidance system primarily for tillage and grassland operations. Integrated in the Varioterminal 7", it offers an accuracy of +/- 20 cm. Please note that VarioGuide light cannot be upgraded to higher accuracies.

#### VarioGuide automated steering system



With VarioGuide, operators can concentrate fully on the implement. That increases performance and has a positive impact on the overall quality of work, even in poor visibility conditions. In addition to the US GPS satellites, VarioGuide, which is operated with the Varioterminal, is capable of using the Russian GLONASS satellite system and is also ready for use with the planned European Galileo system. The parallel use of several systems guarantees that the automatic steering system is highly reliable.



The antenna unit can be transferred quickly and easily between pre-equipped machines in a matter of minutes. The individual components, such as the antenna, receiver and roll bias compensation unit are accommodated in a compact housing unit and fully integrated in the roof. The antenna is therefore optimally protected against external influences such as blows from branches or theft.



You can choose from many service providers for the correction signals. VarioGuide works with satellite-based signals, such as EGNOS or OmniSTAR, as well as ground-based RTK signals via radio or mobile network (NTRIP). VarioGuide supports open formats such as RTCM 3.1. You therefore have the choice of three accuracy classes from +/- 20 cm to +/- 2 cm. RTK offers the highest accuracy.

#### VarioGuide light – the simple guidance system



VarioGuide light attains an accuracy class of +/- 20 cm through the free EGNOS correction signal or American WAAS system. If these correction signals are not available, VarioGuide light runs in Autonomous mode. Here the deviation of the position of the tractor is calculated with a software filter, where the signals from the GPS and GLONASS satellites are compared and adjusted to each other.

### Fast data transfer

VarioDoc is the solution for easy and fast documentation. The software enables modern job management through automatic, gap-free data logging to the field database. Data is transferred wirelessly via Bluetooth. Modern fleet management is perfected through the enhanced version, VarioDoc Pro. It also logs position data and can even transfer these via the mobile network.

### AgCommand™ telemetry pre-fitting

VarioDoc Pro includes preparation for the AgCommand™telemetry system for Fendt tractors. With this solution, you are always informed about where your machines are located and where they were in operation. This allows you to manage your entire fleet perfectly and optimise all your operations.

#### VarioDoc documentation



VarioDoc for modern job management for data logging for field databases. Bluetooth interface enables data transfer.



The starter kit (not included in the scope of delivery of the tractor) provides data exchange between the tractor and the office PC via Bluetooth.

VarioDoc enables wireless data transfer from the Varioterminal to the field database. There is no need to read out data, such as field name and current crop, inputs used and quantity, operator, etc., onto a storage medium. VarioDoc Pro continually records position and machine data and data transfer is possible via mobile network.

Manufacturer	Compatible products
BASF	BASF field record
Helm	MultiPlant • MYFARM24.DE • MYFARM24.LOGISS
LAND-DATA EUROSOFIT	AO Agrar-Office field database • AO Agrar-Office Lohnunternehmer • AO Agrar-Office AutoDok
AGROCOM	AGROCOM-NET • AGROCOM-LU
Farm Works	Farm Works Software

#### AgCommand™ telemetry

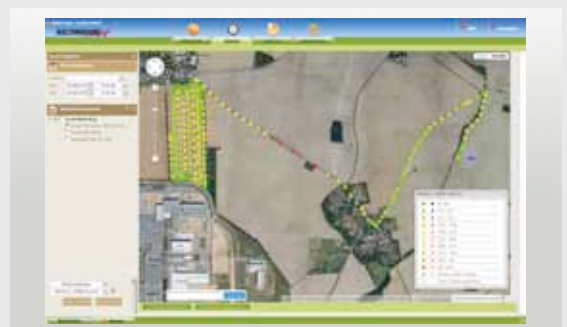
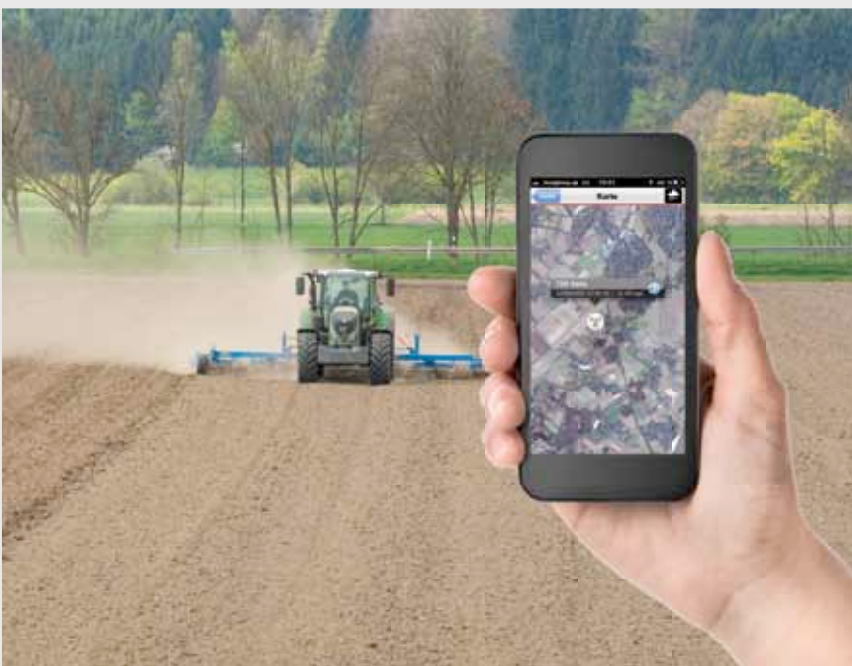

AgCommand™is the cross-brand telemetry solution from the AGCO Corporation. When a Fendt tractor is connected with AgCommand™, the following data is automatically logged:

- Fuel consumption l/ha
- Ground speed km/h
- Engine speed rpm
- Pulling power demand N
- Rear linkage position in %
- Front linkage position in %
- PTO speed rear
- Status operating hour counter
- Outside temperature in °C

## Mounting areas

# Perfectly equipped

The ideal line when grubbing, pass-to-pass accuracy when sowing, the perfect cut when mowing – with the Fendt 700 Vario, your work nears perfection and you will be highly satisfied with the results. The numerous interfaces and automated functions offer you maximum versatility for mounting implements. Powerful hydraulics facilitate and expand the areas of application for maximum efficiency and the best productivity.





## Full function for front and rear

### Powerful hydraulics

With a delivery capacity of 193 litres per minute, the load-sensing pump on the Fendt 700 Vario provides high volume capacity for the hydraulics. These pumps for the Profi and ProfiPlus variants have an easy time with the most demanding implement operations. Additional pumps with a delivery capacity of 152 l/min and 109 l/min (Power) perform strongly with all implements. These pump capacities permit the engine speed to be kept low, which saves fuel effectively, even during demanding operations.

Electric hydraulic oil filter monitoring provides assistance, for example, through fast fault diagnostics. It also shows the next maintenance intervals, which are twice as long, thanks to the monitoring. The transmission oil lasts long thanks to the separate transmission oil and hydraulic oil supplies – oil cannot mix and dirt is prevented from entering the transmission.



The Fendt 700 Vario offers you the best solutions for your individual requirements in three equipment variants – Power, Profi and ProfiPlus. A number of features and mounting areas are already found in the front alone: top link, up to two double-acting control valves, unpressurised return front, seven-pin socket, front PTO (1000 rpm), EPC front linkage incl. shock load stabilising, lower link catch hooks, foldable lower links, shut-off cock.

### Front mounting areas



The front linkage is fully integrated in the half-frame and therefore especially stable. The lower links on the front linkage can be folded up diagonally - which provides more free space for front loader work.



The integrated front PTO delivers 1000 rpm. The direct drive line from the engine to the implement means high efficiency.



### Weight lifter in best form

Thanks to its stable design, the Fendt 700 Vario has a lift capacity of 104 kN and can manage the heaviest loads. On the comfort front linkage with load relief control, the implement can be lowered with the double-acting front linkage valve and the weight of the implement can be transferred to the front axle. This is a particular advantage when operating a snow plough or front mower, since implement guidance can be adjusted quickly and uniformly to uneven surfaces. Relief springs for the mower are no longer required.

#### Comfort front linkage with load relief control



➔ The load relief control for the front linkage is a particular advantage when operating a snow plough or a front mower in grassland operations, since implement guidance can be quickly adjusted to uneven surfaces.

#### Hydraulic system

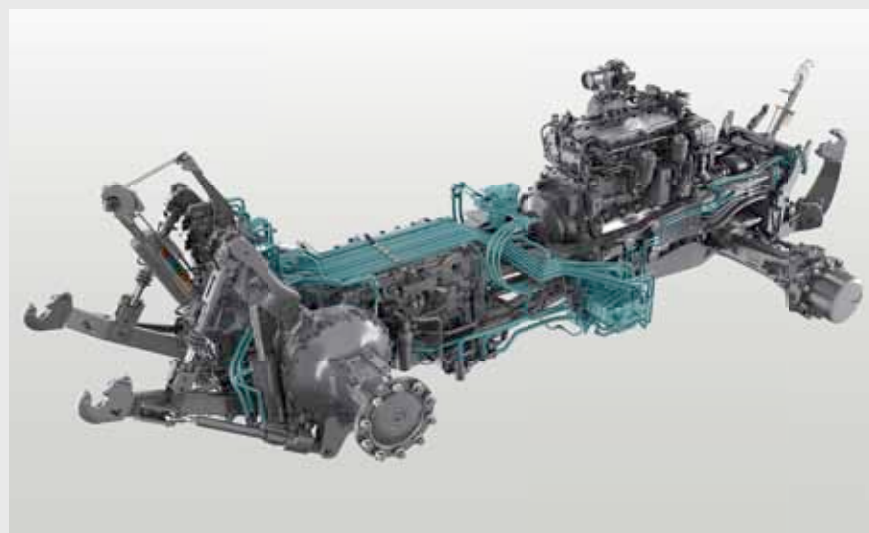

#### DCUP couplings



➔ The DCUP couplings permit the hydraulic valves to be coupled under pressure on both sides; mounting and removing implements is easy. The self-closing valve flaps offer secure protection against contamination through dirt or water.

## Variotronic implement control ISOBUS

### The right speed

No matter which PTO implement you are using, on the Fendt 700 Vario you can demand power exactly when it is needed. Four PTO speeds with 540, 540E, 1000 and 1000E rpm are available. The new 1000E PTO provides optimal power transmission for implements with a high speed demand and simultaneously a low power requirement, for example, operations with a rotary harrow, slurry pump or plant protection sprayer.

### More pressure with power beyond

The power beyond connection comprises a pressure line, a control line and a return for hydraulic oil. The control line regulates the output of the hydraulic pump dependent on the oil requirement of the implement. The pressure line has especially good flow for high hydraulic oil volumes. The oil is transported directly to where it is needed, quickly and without power losses.



All the interfaces at the rear are arranged functionally and clearly: hydraulic top link, up to five spool valves, unpressurised return, compressed air brake, pressure and control line power beyond, hydraulic trailer brake, 7-pin socket, lower link catch hooks, ABS socket, ISOBUS socket, hitch, rear PTO 540, 540E, 1000 and 1000E rpm, bottom hitch and steering axle automatic.

### Compressed air Duomatic coupling

Fast hitching and unhitching of implements made easy: The Duomatic coupling connects compressed air brake lines from trailers or loading wagons with just one hand movement.

### External controls at the rear

The externally operated functions at the rear simplify coupling and uncoupling implements when standing. The rear linkage and the PTO can be operated from both sides. One control unit, for example for the hydraulic top link, can be operated on the rear left side.

#### Power beyond



Power beyond pressure and control line for full hydraulic power transmission

#### External controls rear linkage



➤ Additionally, one valve can be operated externally on the rear mudguard, which makes mounting implements much easier.

#### ISOBUS socket



➤ Connection for the ISOBUS implement control.

#### Rear PTO



➤ Rear PTO with 540, 540E, 1000 and 1000E rpm speeds The external PTO actuation at the rear is especially convenient.

#### Automatic steering axle lock



The optional automatic steering axle lock automatically unlocks the steering axle at a predefined speed on trailers with self-steering axles. On straight stretches, the rigid self-steering axle ensures stable handling. Operators do not need to lock the self-steering axle manually outside of the preselected speed range and when reversing.

## Because just lifting weight would be too easy...

### The Vario and Cargo form a perfect unit

The 700 Vario is ideal for front loader work. The upward viewing angle has been tripled thanks to the new front windscreen. Operators have the front loader in full view, even when it is raised. The front window of the 700 Vario can be fully opened at any time while the front loader is in use. That makes front loader work a true pleasure.

### Optimal operating interface concept

The controls for the Fendt Cargo are optimally integrated in the overall operating interface on the right armrest and in the Varioterminal: you control the front loader with your right hand on the crossgate lever, your left hand is free for steering and reversing and you can control the travel speed with your foot. The CargoProfi represents the absolute pinnacle in front loader operation.



On the Fendt CargoProfi, for example, the tipping angle can be limited when loading very high trailers. The Memo function is especially practical for repeating sequences, for example, the horizontal lower position can be targeted automatically. The weighing function permits monitoring of the weight of the load.

#### Attachment lock



 Membrane keypad for attachment lock and activation of damping

#### Controls



Display for crossgate lever and weighing system: individual and total weight and limiting of the working range for the arm and attachment.

#### Multi-coupler



Standard multi-coupler for fast mounting and removing.

### Smart functions of the CargoProfi

The new Fendt CargoProfi\* is the consistent further development of the tractor and front loader unit. New measuring and tilt sensor systems as well as a job computer enable new functions. These are a weighing function for individual and total weight, for example, for monitoring when loading salt or gravel, as well as the memo function for saving the positions of the arm and attachment or also a shake function. The settings are easy to adjust and view in the Varioterminale.

\*available for the front loader models 5X/85 and 5X/90

### Torsion-resistant arm for rugged jobs

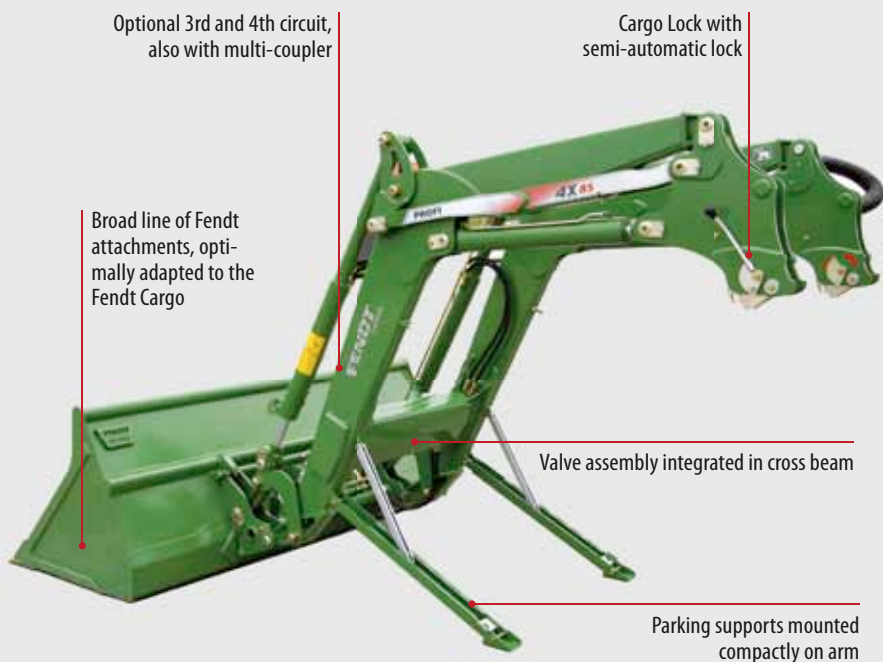

### The features of the Fendt CargoProfi

- Weighing function: Loads are weighed with the push of a button, both individual and total weight possible
- Working range, such as lifting height and tilt angle, can be limited
- Memo function: Save positions for arm and attachment
- End position damping
- Shake function
- Speed-dependent damping (automatic enabling and disabling)

Model		4X/85 <sup>2)</sup>	5X/85	5X/90
<b>A</b>	Digging depth (mm) <sup>1)</sup>	130	290	250
<b>B</b>	Lifting height (mm) <sup>1)</sup>	4150	4460	4500
<b>C</b>	Dumping distance (mm) <sup>1)</sup> B = 3.5 m	1540	1910	1870
<b>C</b>	Dumping distance (mm) <sup>1)</sup> B = max.	950	1120	1080
<b>D</b>	Angle of emptying	55°	55°	55°
<b>E</b>	Angle of backwards tilt	48°	48°	48°
	Lift capacity over full height (daN)	2600	2600	2950
	Max. lift capacity (daN)	3000	3000	3460

<sup>1)</sup> depends on tyres

<sup>2)</sup> only for 28" front tyres

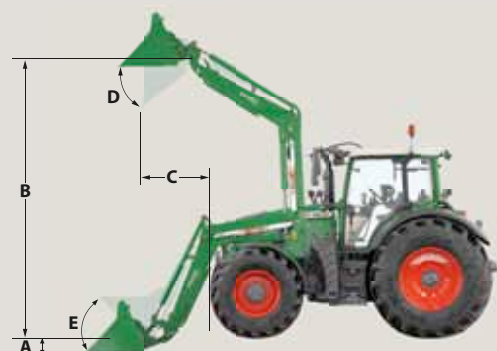

## Cutting edge technology united

In the 700 Vario, start-of-the-art technology is optimally merged in a single vehicle, which gives professional farmers and business owners the economic edge.

1. Front drive axle with 52° steering lock
2. Hydropneumatic front axle suspension with self-levelling and 2 cylinders (lockable)
3. Front linkage with external controls
4. Front PTO
5. 2 da hydraulic connections at the front
6. Planetary final drive
7. 6.06 l Deutz engine with 4 valves per cylinder
8. Cooler unit
9. SCR catalytic converter
10. Continuously variable Vario transmission
11. Hydro motor
12. Hydraulic pump
13. Enclosed 4WD clutch
14. Fuel tank with 400-l capacity
15. AdBlue® tank with 38-l capacity
16. Planetary axle
17. Multi-disc brake for rear wheels
18. Cardan brake for front wheels
19. Rear linkage with hydraulic lateral stabilisation
20. VisioPlus cab with integral automatic climate control and over 6 m<sup>2</sup> of glazing
21. Pneumatic cab suspension
22. Multi-function armrest with Variocentre
23. Varioterminal with integral Fendt VarioGuide automated steering system and ISOBUS
24. VarioGuide roof unit
25. Air-suspended Evolution Dynamic super comfort seat with climate control, seat heating, pneumatic lumbar support
26. Comfort passenger seat with automatic seat belt
27. Ext. rearview mirror, electrically adjustable, heated
28. External rear controls for linkage, PTO and one hydraulic control unit
29. LED main/dipped lights
30. External exhaust gas recirculation
31. Rear PTO 540/540E/1000/1000E
32. 300-degree wiper
33. Particulate filter CSF

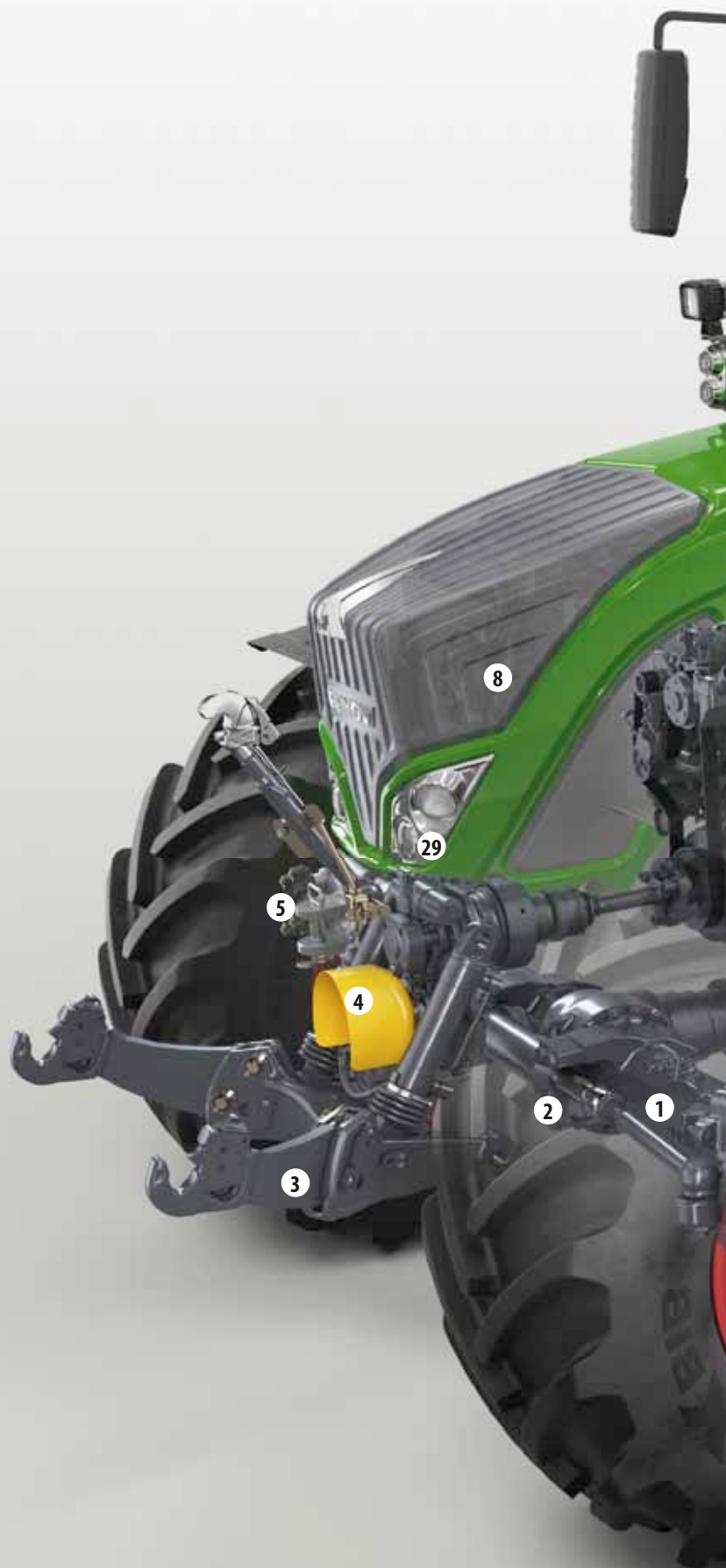



9

24

20

27

23

22

25

26

32

28

FENDT 724

33

21

14

30

30

31

19

7

11

10

17

16

12

13

18

15

6

## Fendt 700 Vario Power version



## Fendt 700 Vario Profi and ProfiPlus version



Photos show optional equipment

Fendt	714	716	718	720	722	724
<b>Engine</b>						
Rated power (kW/hp) (ECE R24)	94 / 128	108 / 148	121 / 165	136 / 185	151 / 205	162 / 220
Max. power (kW/hp) (ECE R24)	107 / 145	121 / 165	132 / 180	147 / 200	162 / 220	176 / 240
Rated power (kW/hp) (EC 97/68) <sup>4)</sup>	106 / 144	120 / 163	133 / 181	148 / 201	163 / 222	174 / 237
Max. power (kW/hp) (EC 97/68)	110 / 150	125 / 170	139 / 188	153 / 208	168 / 229	181 / 246
No. of cylinders / cooling	6/water	6/water	6/water	6/water	6/water	6/water
Cylinder bore / stroke (mm)	101 / 126	101 / 126	101 / 126	101 / 126	101 / 126	101 / 126
Cubic capacity (cm <sup>3</sup> )	6056	6056	6056	6056	6056	6056
Rated engine speed (rpm)	2100	2100	2100	2100	2100	2100
Speed at max. power (rpm)	1800	1800	1800	1800	1800	1800
Max. torque (1450 rpm)	650	725	804	897	988	1058
Torque rise (%)	43	40	39	39	39	38
Fuel tank capacity (l)	400	400	400	400	400	400
AdBlue® (l)	38	38	38	38	38	38
Oil change interval (operating hrs)	500	500	500	500	500	500

Transmission/PTO						
Type: Continuously variable Vario transmission	ML 140	ML 140	ML 180	ML 180	ML 180	ML 180
Speed range:						
Range I - field (forward / reverse)	0.02 to 28 km/h / 0.02 to 17 km/h					
Range II - road (forward / reverse)	0.02 to 50 km/h / 0.02 to 33 km/h					
Maximum speed (km/h)	50	50	50	50	50	50
Rear PTO (rpm)	540/540E/1000/1000E					
Front PTO (rpm) <sup>1)</sup>	1000					

Linkage						
Displacement pump pressure (200 bar) (l/min) (options)	109 (152/193)	109 (152/193)	109 (152/193)	109 (152/193)	109 (152/193)	109 (152/193)
Rear linkage control	EPC	EPC	EPC	EPC	EPC	EPC
Additional valves max. (standard)	7 da <sup>3)</sup> (2 da <sup>3)</sup> electr. valves / crossgate lever					
Max. lift capacity, rear linkage on the draw-bar (daN)	10360	10360	10360	10360	10360	10360
Max. lift capacity, front linkage (daN)	4418	4418	4418	4418	4418	4418
Implement weight / front linkage up to (kg)	3180	3180	3180	3180	3180	3180

Weights and dimensions						
Unladen weight	7735	7735	7980	7980	7980	7980
Perm. overall weight (kg)	12500	12500	14000	14000	14000	14000
Max. vertical hitch load with standard tyres and 50 km/h (kg)	2000	2000	2000	2000	2000	2000
Overall length (mm)	5240	5240	5240	5240	5240	5240
Overall width (mm)	2550	2550	2550	2550	2550	2550
Overall height (mm)	3050	3050	3050	3050	3050	3050
Ground clearance (mm) <sup>2)</sup>	506	506	506	506	506	506
Wheelbase (mm)	2783	2783	2783	2783	2783	2783
Track width front (mm) <sup>2)</sup>	1950	1950	1950	1950	1950	1950
Track width rear (mm) <sup>2)</sup>	1920	1920	1920	1920	1920	1920
Min. turning circle (m)	5.5	5.5	5.5	5.5	5.5	5.5

Electrical equipment						
Starter (kW)	4.0	4.0	4.0	4.0	4.0	4.0
Battery (V/Ah)	12 / 180	12 / 180	12 / 180	12 / 180	12 / 180	12 / 180
Alternator (V/A)	14 / 200	14 / 200	14 / 200	14 / 200	14 / 200	14 / 200

Tyres						
Standard front	480/70 R28	540/65 R28	540/65 R28	540/65 R30	540/65 R30	540/65 R30
Standard rear	580/70 R38	650/65 R38	650/65 R38	650/65 R42	650/65 R42	650/65 R42
Optional front	540/65 R30	540/65 R30	540/65 R30	600/65 R28	600/65 R28	600/65 R28
Optional rear	580/70 R42	580/70 R42	650/65 R42	710/70 R38	710/70 R38	710/70 R38
Optional front	16.9 R28	16.9 R28	600/65 R28	600/65 R28	600/65 R28	600/65 R28
Optional rear	20.8 R38	20.8 R38	710/70 R38	650/75 R38	650/75 R38	650/75 R38
Optional front	600/60 R28	600/60 R28	600/60 R30	600/60 R30	600/60 R30	600/60 R30
Optional rear	710/60 R38	710/60 R38	710/60 R42	710/60 R42	710/60 R42	710/60 R42
Optional front				320/85 R38 <sup>5)</sup>	320/85 R38 <sup>5)</sup>	320/85 R38 <sup>5)</sup>
Optional rear				320/90 R54 <sup>5)</sup>	320/90 R54 <sup>5)</sup>	320/90 R54 <sup>5)</sup>

<sup>1)</sup> = optional, <sup>2)</sup> = with 710/70R38 tyres, <sup>3)</sup> = can also be used as single-acting, <sup>4)</sup> = power specifications for registration<sup>5)</sup> = Recommended for row crop tyres, not offered by Fendt

Your Fendt dealer will be pleased to inform you about further tyre options.



Equipment levels	Power	Profi	ProfiPlus
<b>Vario operation</b>			
Multi-function joystick	●	●	●
Varioterminal 7" with touchscreen and key control	●	●	●
Varioterminal 10.4-B with touchscreen and key control		□	●
Variotronic implement control ISOBUS		●	●
SectionControl			□
Variotronic <sup>1)</sup> – headland management system	●	●	●
Vario TMS – engine-transmission management system	●	●	●
VarioDoc documentation system		□	●
VarioDoc Pro - documentation system / AgCommand™		□	□
Preparation for automated steering			● <sup>1)</sup>
VarioGuide automated steering system			□
VarioGuide light automated steering system		□	
VarioActive steering			●
Electronic immobiliser	●	●	●
Without immobiliser	□	□	□
Variotronic <sup>1)</sup> automatic			□

Cab	Power	Profi	ProfiPlus
Split windscreen and door on right	□	□	□
Continuous windscreen	●	●	●
Pneumatic cab suspension	●	●	●
Pneumatic comfort cab suspension		□	□
Height and tilt-adjustable steering column	●	●	●
Comfort Seat, air-sprung with backrest	●	●	●
Super comfort seat with seat heater, lumbar support	□	□	□
Super comfort seat Evol. dynamic DuMo / DL	□	□	□
Super comfort seat 3-point belt	□	□	□
Passenger seat with automatic seat belt	●		
Comfort passenger seat with automatic seat belt		●	●
Floor mat	□	□	□
Radio mounting kit with two speakers	●	●	●
Radio CD MP3 Blaupunkt	□	□	□
Radio with hands-free speaking system	□	□	□
Two additional coaxial speakers		□	□
Tachograph	□	□	□
Air-conditioning	●	●	●
Automatic climate control		□	□
Pollutant filter (aerosol)	□	□	□
Segment wipers front	●	□	□
Parallel wipers front	□	□	□
300-degree wiper front		● <sup>2)</sup>	● <sup>2)</sup>
Rear window heated	□	□	□
Rear window wash/wipe	□	□	□
Ext. rearview mirror, mechanically adjustable	●	●	●
Ext. rearview mirror, electrically adjustable, heated		□	□
Wide-angle mirror	□	□	□
Interior rearview mirror		●	●
Corner light / chrome trim turn signal indicator light		●	●
LED corner light		□	□
Work lights roof, 4 rear, 2 front	●	●	●
Work lights A-pillar, roof front, mudguard rear	□	□	□
Work lights LED A-pillar, rear mudguards, 4 roof rear, 4 roof front	□	□	□
LED headlamps with headlamp levelling		□	□
LED rear light	□	□	□
Ambient lighting	●	●	●
Auxiliary device holder (choice of 2)	□	□	□
Cooling compartment	●	●	●
Battery disconnect	□	□	□
Add. storage space, 12 Volt left, light in roof liner left		●	●

Engine	Power	Profi	ProfiPlus
Fuel pre-filter	●	●	●
Fuel pre-filter (heated)	□	□	□
Preheater package (engine, transmission, hydraulic oil)	□	□	□
Exhaust brake	□	□	□

Transmission	Power	Profi	ProfiPlus
Shuttle function, stop-and-go function	●	●	●
Acoustic signal when reversing		□	□

Equipment levels	Power	Profi	ProfiPlus
<b>Chassis / safety features</b>			
Compressed air system	●	●	●
Automatic trailer steering axle lock		□	□
Compressed air Duomatic coupling	□	□	□
Dual-circuit braking system 1 pedal	●	●	●
Dual-circuit braking syst., 2 pedals + steering clutch brake		□	□

4WD / differential locks	Power	Profi	ProfiPlus
Comfort engagement controls for 4WD / differential locks	●	●	●
Rear / front differential with 100% disc locking	●	●	●
Power shift PTOs	●	●	●
Rear: Flanged PTO 540/540E/1000/1000E rpm	●	●	●
Front: 1000 rpm	□	□	□
External controls for rear PTO	●	●	●

Hydraulics	Power	Profi	ProfiPlus
Load sensing system with axial piston pump (109 l/min)	●		
152 l/min delivery capacity	□	●	●
193 l/min delivery capacity		□	□
Electrohydraulic rear linkage sa (EPC)	●	●	●
Electrohydraulic rear linkage da (EPC), with external controls		□	□
Control with linear elements		●	●
1st and 2nd hydraulic valve at rear	●	●	●
3rd hydraulic valve at rear	□	●	●
4th hydraulic valve at rear or 3rd hydraulic valve at rear and 1st hydraulic valve in front	□		
4th to 5th hydraulic valve at rear		□	□
1st to 2nd hydraulic valve in front		□	□
Hydraulic lower link lateral stabiliser		□	□
Radar sensor		□	□
Top link rear hydraulic	□	□	□
External hydraulic connection (load sensing)	□	□	□
Hydraulic valve actuation crossgate lever, connect-under-pressure couplings rear	●	●	●
Double connect-under-pressure lever couplings rear	□	□	□
Easy ballast weight pick-up without front linkage	□	□	□
Front linkage da with external controls	□	□	□
Comfort front linkage da with position control, ext. controls	□	□	□
Comfort front linkage DA, with position control and relief control, external controls	□	□	□

Body	Power	Profi	ProfiPlus
Auto. hitch with remote control, rear	●	●	●
Ball-type coupling, height adjustable	□	□	□
Ball-type coupling normal in the bottom hitch	□	□	□
Ball-type coupling long in the bottom hitch	□	□	□
Forced steering (single or double-sided)	□	□	□
Hitch	□	□	□
Swinging drawbar	□	□	□
Piton-fix	□	□	□
Rotating beacon left and right	□	□	□
Wide vehicle marker	□	□	□
Pivoting front wheel mudguard	●	●	●
Front weights, various sizes	□	□	□
Ballast weights for rear wheels	□	□	□
Design Line		□	□
Paint body Nature Green, rims Terra Red	□	□	□

Front loader	Power	Profi	ProfiPlus
Front loader attachment parts	□	□	□
Front loader Cargo 4X/85	□	□	□
Front loader Cargo Profi 4X/85	□	□	□
Front loader Cargo 5X/85	□	□	□
Front loader Cargo Profi 5X/85	□	□	□
Front loader Cargo 5X/90	□	□	□
Front loader Cargo Profi 5X/90	□	□	□

<sup>1)</sup> = including VarioGuide roof hatch  
<sup>2)</sup> = with one-piece windscreen

## Leaders drive Fendt.

You have to experience the ingeniousness of a Fendt Vario for yourself, down to the last detail. Test a Fendt, convince yourself and make the right investment.



### **Invest in profitability**

Overall profitability distinguishes the entire product line of the technology brand Fendt. The efficiency of the products guarantees the best cost-effectiveness per hectare. In combination with the extremely high retention of value of a Fendt, you also get an unbeatable resale value at the end of your tractor's service life. As a trendsetter, Fendt continually sets important new standards and installs technology that continues to be in demand in the future. Add to that the high quality, which stands for operational reliability and a long life. The total is retention of value that only Fendt can offer you.



### Certified quality

We achieve a constant, excellent premium quality through first-class workmanship and use high-grade materials for all components. In the development phase, the tractors undergo comprehensive testing, with up to 10,000 engine hours under the toughest conditions, to thoroughly test the durability of components. In series production, Fendt relies on comprehensive testing processes to ensure that each individual tractor leaves the factory with the highest quality.



### We offer more – join us!

Fendt not only offers high-quality products with cutting-edge technology, but also assists you in getting the most out of your Vario. With the help of our Fendt driver training Fendt Expert, you can further optimise profitability and learn to make all the settings and adjustments to drive at an absolute optimum in different operations.



### More freedom for investments

Tailor-made financing from AGCO FINANCE and the customised service package: A custom financing package with attractive conditions and flexible terms offers you an ideal opportunity to match your investment to the needs of your farm or business. With a Fendt Service Package, you also have servicing and repair costs under control. When purchasing your tractor, you can already plan the prescribed service work based on attractive fixed prices – with the Service or comprehensive ProService package.

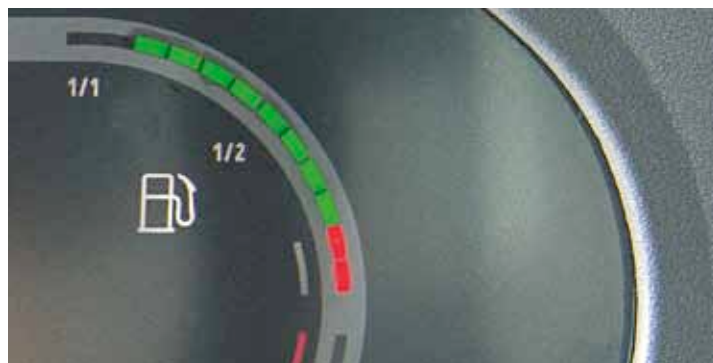

### Efficiency – for our customers' success

Efficiency is the recipe for successful financial management in agriculture. We make no compromises when it comes to efficiency, because our objective is to be the leader for cost-effectiveness per hectare and kilometre. The very best technology is just good enough here, for example, as is found in our tractors: the highly efficient Vario drive train and the fuel-saving SCR technology in combination with TMS.

# FENDT

## Leaders drive Fendt



[www.fendt.com](http://www.fendt.com)

AGCO GmbH – Fendt Marketing  
87616 Marktoberdorf, Germany

Sales agent:



**Fendt is a worldwide brand of AGCO.**

All data regarding delivery, appearance, performance, dimensions and weight, fuel consumption and running costs of the vehicles correspond with the latest information available at the time of going to press. Changes may be made before the time of purchase. Your Fendt dealer will be pleased to supply you with up-to-date information. Vehicles are not shown with country-specific equipment.