

**PREMIUM.
POWERFUL.
PERFORMANCE.**



Cub Cadet[®]
Drive it...we DARE you!

Cub Cadet
Drive it...we DARE you!

WE SAY DRIVE IT...WE DARE YOU BECAUSE WE KNOW YOU WILL LOVE THE POWER, CONTROL AND PRECISION ONLY A CUB CAN DELIVER.

Cub Cadet equipment delivers the ultimate in productivity through a combination of sustained power, detailed precision and complete control. Innovation drives the design, engineering and function of every Cub Cadet and we've been backing this up for decades by building products that work hard at maintaining your lawn and garden.

We pride ourselves on providing you, the customer, with quality products that are comfortable to use and exceed your expectations.

Want to experience the power, precision and control for yourself? Book a test drive with your local Cub Cadet Dealer today.

Drive it...we DARE you!



TABLE OF CONTENTS

| | |
|--------------------------|-------|
| XT Enduro Series™ | 4-7 |
| Ultima Series™ | 8-9 |
| Ultima Series™ ZT1 & ZT2 | 10-11 |
| Ultima Series™ ZTX | 12-13 |
| RZT® S Series | 14-15 |
| Z-Force® SX Series | 16-17 |
| Wheeled String Trimmer | 18-19 |
| HW PRO Series | 20 |
| PRO X Series | 21 |
| PRO Z Series | 22-23 |
| PRO Z 100 S Series | 24-25 |
| PRO Z 500 S Series | 26-27 |
| PRO Z 700 S Series | 28-29 |
| PRO Z 900 S Series | 30-31 |
| PRO Z 900 SD Series | 32-33 |
| PRO Z 900 SDL Series | 34-35 |
| Full Specifications | 36-43 |



BUILT IN AMERICA SINCE 1961

Since 1961, Cub Cadet lawn and garden tractors and zero turns have been proudly Built In America. All products are designed, engineered and built using the highest quality components sourced locally and globally. Based in Valley City, Ohio, the Cub Cadet brand is sold worldwide and represents American Ingenuity at its Best™.

SEE IT
IN ACTION.

Visit www.cubcadet.com.au on your mobile device.
Product Details | Videos | Locate a Cub Cadet Dealer



WARRANTY

6-year unit domestic warranty. 90 day unit commercial warranty.
6-year engine domestic warranty. 90 day engine commercial warranty.

XT1 ENDURO SERIES™

- XT1 LT 42 & XT1 LX 42

(See page 36 for full specifications)



INTELLIPOWER™
OPTIMISED ENGINE TECHNOLOGY

- XT1 LT 42



- XT1 LX 42

POWER FOR THE LONG RUN.

The next generation of ride on mowers is here, the XT1 Enduro Series is the industry benchmark with power, comfort, precision and control for the ultimate mowing experience. Loaded with features, The XT1 Enduro Series is ideally equipped for easy mowing and hauling around the yard.

- Power On A Whole New Level**
 The LT 42 features a 547cc Cub Cadet single OHV engine with IntelliPower™ technology that provides more available power under wet, heavy loads resulting in less bogging down and more consistent cutting. The LX 42 has a 24HP Kawasaki® V-Twin OHV engine giving you the power to get the job done quickly.
- Advanced Cutting Performance**
 A muscular cutting system featuring a 107cm (42") stamped deck built with heavy-duty material and an advanced belt design ensures durability and reliability while delivering the pristine Cub Cadet Signature Cut™.
- Incredibly Responsive Handling**
 With a tight 16" turning circle that enables you to manoeuvre around obstacles on your lawn, the XT1's steering system delivers optimised command and control at every turn.
- Added Comfort**
 High-back seats (LX 42 features armrests), comfort-grip steering and overall ergonomics are designed to keep you comfortable for extended periods.



Advanced Cutting Performance



Responsive Handling



Added Comfort
(armrests available on LX 42 only)



WARRANTY

6-year unit domestic warranty. 90 day unit commercial warranty.
6-year engine domestic warranty. 90 day engine commercial warranty.

XT2

ENDURO SERIES™

• XT2 LX 42 & XT2 LX 46

(See page 36 for full specifications)



• XT2 LX 42



NEW

• XT2 LX 46

STRENGTH FROM START TO FINISH.

Cub Cadet XT2 ride on mowers are ideal for more challenging terrain as well as hauling with responsive handling, versatility and the durability you can trust.

The XT2 LX 42 delivers smarter tech features such as Electronic Fuel Injection and Push Button Start. The XT2 LX 46 features a Kawasaki® engine and a larger, fabricated deck for added durability.

• Stronger Engine Choices

The LX 42 with a 679cc Cub Cadet® Electronic Fuel Injected (EFI) engine helps to reduce maintenance, providing up to 25% less fuel consumption of an equivalent carburettor. The EFI engine also offers Push Button Start (PBS) giving you keyless starts – just push a button and go. The LX 46 ride on mower features a powerful 24HP Kawasaki® engine for larger, more challenging areas.

• Comfort With Added Extras

An open high-back seat with armrests ensures you stay comfortable for extended periods, along with a standard front bumper and cruise control as well as LED headlights for maximum visibility.

• Auto Traction Control

Automatic locking rear differential for all weather conditions and cutting terrains available on both the LX 42 and LX 46.



Stronger Engines
(EFI Shown)



Responsive Handling



Comfort Extras

ULTIMA SERIES

STEP UP TO A HIGHER STANDARD.

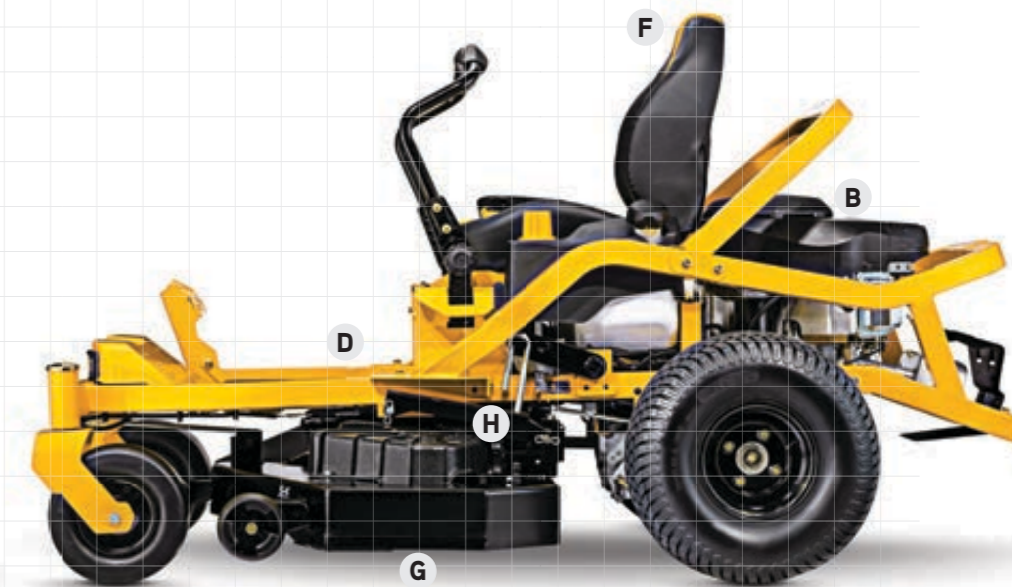
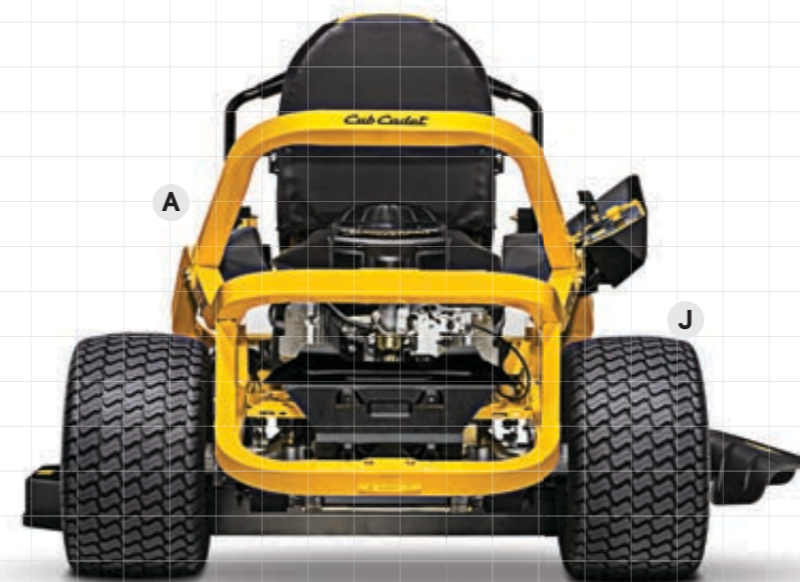

Forged for Enhanced Strength and Durability

- A:** Continuous tubular steel frame
- B:** Premium Kawasaki® engines

Redefined Comfort

- C:** Durable, advanced polymer seat
- D:** Rubber floor mat and ample legroom
- E:** Industry-exclusive overmoulded rubber hand grips
- F:** Automotive-inspired, ergonomic, fully adjustable high-back seat

Best-in-Class Cut Quality for the Perfect Pass

- G:** Full-welded fabricated steel deck
- H:** 15-position deck height adjustments

- I:** Offset front axle for precise trimming
- J:** Premium tyre set

Maintain With Ease

- K:** Maintenance-free spindles
- L:** Hinged floor pan for easy deck access
- M:** 3 year domestic unit warranty*



WARRANTY

3-year unit domestic warranty. 90 day unit commercial warranty.
 3-year engine domestic warranty. 90 day engine commercial warranty.
 5-year fabricated deck shell domestic warranty.

ULTIMA SERIES™

- ZT1 42, ZT1 46 & ZT2 54

(See page 38 for full specifications)

Kawasaki
— ENGINES —



NEW
• ZT1 42



• ZT1 46



• ZT2 54

RESHAPING THE LANDSCAPE.

INTRODUCING THE ULTIMA SERIES™ ZT.

Step up to the ultimate all-around mowing experience with unrivalled strength, comfort and performance. The best-in-class cut on the Ultima Series™ ZT will bring you one step closer to your best lawn yet.

■ Tough Build

A continuous 5cm x 5cm tubular steel frame with protective e-coat on its lower end gives you optimal durability and strength with automotive-grade corrosion resistance for long-lasting use.

■ Redefined Comfort

An automotive-inspired, fully adjustable 51cm high-back seat (armrests available on the ZT2 54), ergonomic hand grips and a rubber floor mat let you comfortably cut at a maximum forward speed of up to 12km/h.

■ Best-In-Class Cutting Performance

Independently tested and proven, the fabricated™ deck, in combination with 15-position deck height adjustment options and an offset front axle, deliver a best-in-class cut with fewer clumps, finer clippings and increased evenness.

■ Seamless Maintenance

Highly accessible hinged floor pan for easy deck access and maintenance-free spindles make routine servicing quick and simple.



Rubber Anti-Vibration Footrest



Ergonomic Control Panel



Easy Dial Deck & Height Adjustment

3
YEAR
DOMESTIC

2
YEAR
COMMERCIAL

WARRANTY

3-year unit domestic warranty. 2-year unit commercial warranty.
3-year engine domestic warranty. 2-year engine commercial warranty.
5-year fabricated deck shell domestic warranty.



ULTIMA SERIES™

- ZTX5 48, ZTX5 54 & ZTX5 60

(See page 39 for full specifications)

Kawasaki
— ENGINES —



Lap Bar Control



• ZTX5 48



• ZTX5 54



• ZTX5 60

STEP UP TO ANY CHALLENGE.

INTRODUCING THE ULTIMA SERIES™ ZTX.

The professional-grade build of the Ultima Series™ ZTX zero turns deliver enhanced strength and durability so you can comfortably cut at maximum speed through the most challenging conditions.

- Strength On Deck**
 Built on a 4cm x 8cm tubular frame and featuring a 10-gauge steel fabricated AeroForce Max™ deck with side, top and leading-edge reinforcements and best-in-class bagging capabilities, you will be equipped with the right amount of strength and rigidity for consistent productive mowing.
- Built-In Longevity**
 The professional-grade Kawasaki® engines are backed by a strong 3-year domestic warranty† and service support from our extensive dealer network nationwide to assure the extended lifetime of your machine.
- Command With Comfort**
 Advanced polymer seat isolators, isolated front caster suspension and an automotive class 51cm high-back seat with padded armrests deliver a smooth, quiet ride at up to 14km/h with less vibration than other zero turns.
- Endless Versatility**
 With a full line-up of premium attachments and LED headlights, as well as a standard rollover protection system (ROPS) plus rear tow hitch, build the perfect zero turn package to tackle all of your needs.



Foldable ROPS



Rubber Anti-Vibration Footrest



Ergonomic Control Panel



WARRANTY

6-year unit domestic warranty. 90 day unit commercial warranty.
6-year engine domestic warranty. 90 day engine commercial warranty.

RZT[®]S SERIES

- RZT[®] S 42 & RZT[®] S 46

(See page 37 for full specifications)



- RZT[®] S 42



Synchro-Steer[™]
Technology



- RZT[®] S 46

THE ZERO-TURN WITH ZERO LEARNING CURVE.

Feature for feature, the RZT[®] S gives you more. Zero turn handling combined with the ease of steering-wheel control and four-wheel steering means unmatched stability and unprecedented versatility. There's no doubt you'll become obsessed with its power, performance and incredible precision with unbeatable durability.

- Advanced Manoeuvrability, Confidence And Comfort**
 With the ease of steering-wheel control and stability of four-wheel steering, you'll have unprecedented command over hills of up to 20° slopes and uneven terrain. With the added benefit of high-back seats and armrests for extra comfort, the RZT[®] S Series will keep you comfortable when mowing for longer periods.
- Incredible Performance**
 Your machine is outfitted with a perfect engine that has undergone a rigorous certification process. Our 42-inch pressed steel (RZT[®] S 42) and heavy-duty 46-inch (RZT[®] S 46) decks are equipped with powerful Kawasaki[®] engines giving you the power to take on challenging areas.
- Cub Cadet Signature Cut[™]**
 An advanced cutting system design with optimal flow, blade overlap and floating deck to deliver flawless cutting and low maintenance year after year.



Advanced
Manoeuvrability



Tough Decks &
Advanced Cutting



Added Comfort

WARRANTY
 3-year unit domestic warranty. 1-year unit commercial warranty.
 3-year engine domestic warranty. 1-year engine commercial warranty.
 5-year fabricated deck shell domestic warranty.



Z-FORCE[®] SX SERIES

- Z-Force[®] SX 48 & Z-Force[®] SX 54
 (See page 37 for full specifications)

Kawasaki
 ENGINES



Synchro-Steer[™]
 Technology



• Z-Force[®] SX 48



• Z-Force[®] SX 54

HEAVY DUTY. EASY RIDE.

Feature packed for premium performance, the Z-Force[®] SX Series gives you more. You will not only become confident with the Synchro-Steer[™] four-wheel, car-like steering wheel control, but also an impressive list of professional-feature upgrades. More comfort. More power. More precision. More durability. More reasons you'll look forward to a satisfying day caring for your property.

- ▶ **Advanced Manoeuvrability And Confidence**
 With the ease of steering-wheel control and stability of four-wheel steering, you'll have unprecedented command over challenging areas including hills of up to 20° slopes and uneven terrain.
- ▶ **Incredible Strength**
 Powerful Kawasaki[®] engines, fully welded full-length steel frames and tough fabricated decks with heavy-duty spindles deliver outstanding results year after year.
- ▶ **Amazing Comfort**
 From the moment you sit on the comfortable high-back seat, you'll know you're in for a great ride. Standard armrests, adjustable steering column, a roomy footrest and the easy-lift deck height adjuster are just a few of the features that make this rider great for all-day operation.



Advanced Manoeuvrability



Incredible Strength



Added Comfort



WARRANTY

2-year unit domestic warranty. 90 day unit commercial warranty.
2-year engine domestic warranty. 90 day engine commercial warranty.

18



WHEELED STRING TRIMMER



THE POWER TO CUT IT ALL.

The Cub Cadet wheeled string trimmer has the power to clear tall and thick grasses, heavy brush as well as other vegetation making it ideal for larger, tougher jobs. The offset deck means the trimmer can be used against walls and fence lines while walking in a straight line. Easy to use and manoeuvre, the trimmer cuts through difficult areas with ease putting you in control.

- Simple Height Adjustment**
 Easily change the multi-position cutting height. Lower for trimming along fences, retaining walls and structures; higher for long, thick weeds in a field.
- Exceptional Handling**
 The ball-bearing wheels give remarkable manoeuvrability on uneven terrain. The offset head design easily cuts around obstacles like fence lines and corners.
- Powerful Performance**
 With a powerful Cub Cadet 140cc engine, tackle the tough stuff without worrying about bogging down.

| WHEELED STRING TRIMMER | |
|------------------------|---|
| ENGINE | |
| Engine Type | 140cc Cub Cadet engine, 4-stroke |
| CUTTING | |
| Cutting Width / Height | 56cm (22") / adjustable, 4.1cm (1.6") - 7.6cm (3") |
| WHEELS | |
| Wheel Type | 35.6cm (14") ball bearing wheels |
| HANDLE | |
| Handle Type | Adjustable, 3-position loop |
| WARRANTY* | |
| Warranty | Unit: 2-year domestic and 90 day commercial / Engine: 2-year domestic and 90 day commercial |



Simple Height Adjustment



Exceptional Handling



Powerful Performance



WARRANTY

3-year unit domestic warranty, 2-year unit commercial warranty.
 3-year engine domestic & commercial warranty.
 5-year fabricated deck shell domestic warranty.

HW PRO SERIES

(See page 43 for more details)

UNBEATABLE IN EVERY ENVIRONMENT

Cub Cadet's professional hydrostatic drive walk behind mower, the PRO HW Series, is built for maximum performance and minimal downtime. With innovative steering technology, durable deck and rugged construction, this professional walk behind is tough enough to tackle tough terrain in every environment.

- ▶ **Unmatched Steering**
 Optimal weight distribution and large tyres maximise stability on hillsides and slopes, while hand-lever steering control uses less force to steer the mower meaning less fatigue.
- ▶ **Easy Control**
 Straight-line adjustable tracking allows for on the go straight line adjustments with the turn of a knob and cruise control gives ultimate speed control so you can mow at your own pace.
- ▶ **Durability At Its Core**
 The 10-gauge steel deck shell with 7-gauge top and bottom reinforcements ensure that this cutting deck can take a beating. A 7-gauge leading edge and 1/4" side reinforcements add to the all-round heavy-duty construction. Maintenance-free sealed spindles maximise performance and reduce downtime.

PRO X SERIES

NEW



- PRO X 648

- (See page 43 for more details)

STRENGTH TAKES A STAND

Seize productivity with the latest addition to the Cub Cadet professional line up. The PRO X 648 gives you the zero turn flexibility you need to mow a wider range of properties. The easy-to-adjust suspension platform accommodates any operator while the smooth and highly responsive controls allow for less vibration and peak manoeuvrability, maximising your productivity and comfort.

- ▶ **Unmatched Ground Clearance**
 With a fully fabricated 10-gauge deck shell, 7-gauge top and bottom reinforcements, plus standard 61cm tyres, the PRO X 648 gives you more ground clearance to easily hop on curbs.
- ▶ **Best-In-Class Impact Absorption**
 A large, fully adjustable suspension platform allows you to fine-tune tension and glide comfortably over the roughest of terrains.
- ▶ **Optimised Performance**
 An easy step-on/step-off design allows for quick debris pickup while the bigger 122cm (48") fabricated steel deck maxes out traction and reduces turfing for an even, professional cut.



WARRANTY

3-year unit domestic & commercial warranty.
 3-year engine domestic & commercial warranty.
 5-year fabricated deck shell domestic warranty.



Cub Cadet®



PRO SERIES

BUILT TO ONE STANDARD. YOURS.



We asked commercial users what they expect and demand from their equipment and then started from scratch.

Designing every element of our commercial offering with the professional in mind, we put them through rigorous testing, not finalising our design until we addressed the common setbacks landscapers experience.

The result is a quality professional line-up that lets you take on long seasons of demanding work with confidence.

THE ULTIMATE MANOUEVRABILITY

The Cub Cadet PRO Series is loaded with thoughtful features designed for exceptional performance, unmatched comfort and beautiful results. How you harness this powerful package is up to you but you can expect a mowing experience that's second to none.



UNRIVALLED STEERING WHEEL CONTROL

Steering wheel control — an exclusive in the commercial category — increases productivity, mowing hillsides and terrains that lap bars can't handle.

- ▶ Reduces mowing time by up to 10% compared to lap bar models.
- ▶ Delivers true zero turn handling, less overlap and straighter lines.
- ▶ Four-wheel steering for unmatched hillside stability.

Unmatched hillside confidence

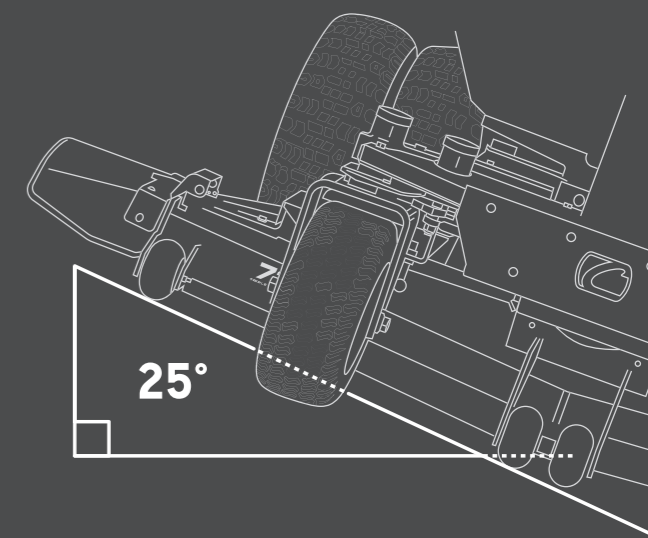

Available on the PRO Z 972 SD and 972 SDL.

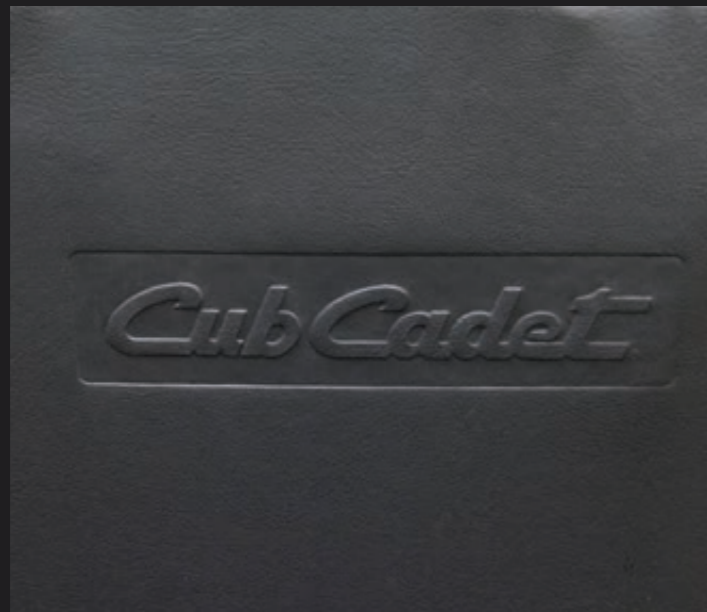



WARRANTY
 3-year unit domestic warranty. 2-year unit commercial warranty.
 3-year engine domestic & commercial warranty.
 5-year fabricated deck shell domestic warranty.

PRO Z 100 S SERIES

- PRO Z 148 S & PRO Z 154 S
(See page 41 for more details)

POWERED BY
KOHLER



Synchro-Steer™
 Technology



Electronic Fuel
 Injection

STRONGER RESULTS WITH GREATER CONTROL.

The PRO Z 100 S Series is built to stand strong with a fully reinforced frame, triple-guard fabricated decks and commercial electronic fuel-injected engines for amazing fuel efficiency. Add four-wheel steering that eliminates turf damage and gives unmatched hillside stability of up to 20° slopes, the PRO Z 100 S Series will give you the confidence that your equipment will work hard all day, every day.

- Power And Efficiency**
 High-performance, maximum-power Kohler® Confidant V-Twin EFI engines provide greater torque and gives up to 25% in fuel savings when compared to an equivalent carburettor for the ultimate in efficiency. The heavy-duty air filter and filtration system ensures a longer engine life so that you'll be cutting with confidence year after year.
- Heavy-Duty Decks With A Professional Cut**
 Extra-tough fabricated decks for added durability that feature anti-scalping wheels at the front and side of the deck to give your lawn a professional looking cut.
- Amazing Comfort**
 From the moment you sit in the comfortable high-back seat, you'll know you're in for a great ride. Standard armrests, adjustable steering column and the easy-lift deck height adjuster are just a few of the features that make this rider great for all-day operation.



- PRO Z 154 S



Powerful, Efficient Engines



Heavy-Duty Decks

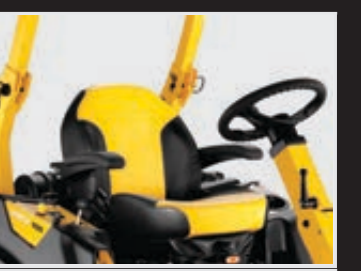

The Ultimate In Comfort



WARRANTY

5-year fabricated deck shell domestic warranty.
 3-year unit domestic & commercial warranty.
 3-year engine domestic & commercial warranty.

PRO Z 500 S SERIES

- PRO Z 554 S
(See page 42 for more details)

Kawasaki
 — ENGINES —



CUTTING EVERYTHING INCLUDING DOWNTIME.

With an incredible combination of strength and comfort features, the PRO Z 500 S Series is a force to be reckoned with. The steering wheel, with Cub Cadet's Synchro-Steer™ Technology, helps eliminate turf damage and provides unmatched stability on up to 20° slopes helping you cover acres up to 10% faster than comparable lap bar units.

- Best-In-Class-Deck**
 Stand up to the toughest conditions with the only commercial lawn mower touting a triple-7-gauge steel cutting deck complete with 7-gauge top and bottom reinforcements, plus 1/4" leading edge and 5/16" side reinforcements. The extra-tough fabricated deck offers added durability that features anti-scalping wheels at the front and side of the deck to give your lawn a professional looking cut.
- Unbeatable Durability**
 The Cub Cadet Triple Guard Corrosion Defense System™ with e-coat delivers automotive-grade corrosion resistance against the elements and wear and tear.
- Amazing Comfort**
 From the moment you sit in the comfortable high-back seat, you'll know you're in for a great ride. Standard armrests, adjustable steering column, an easy-lift deck height adjuster and the ISO mounted foot base that reduces vibrations through the operator's feet, are just a few of the features that make this rider great for all-day operation.



Best-In-Class Deck



Unbeatable Durability

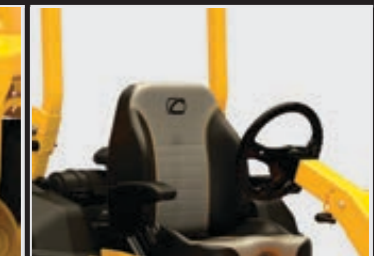

The Ultimate In Comfort



WARRANTY
 3-year unit domestic & commercial warranty.
 3-year engine domestic & commercial warranty.
 5-year fabricated deck shell domestic warranty.

PRO Z 700 S SERIES

- PRO Z 760 S
(See page 42 for more details)

Kawasaki
 ENGINES



AN EASY DAY'S WORK WITH GREATER CONTROL.

The big challenges are no match for the advanced power of the PRO Z 700 S Series. Heavy-duty construction, faster mowing speeds and a larger deck option make this an essential step up for large crews working on extensive jobs. Add steering wheel control and amazing comfort, the PRO Z 700 S Series keeps you working efficiently all day.

- ▶ **Best In Class Deck**
 Stand up to the toughest conditions with the only commercial lawn mower touting a triple-7-gauge steel cutting deck complete with 7-gauge top and bottom reinforcements, plus 1/4" leading edge and 5/16" side reinforcements. The extra-tough fabricated deck offers added durability that features anti-scalping wheels at the front and side of the deck to give your lawn a professional looking cut.
- ▶ **Unbeatable Durability**
 The Cub Cadet Triple Guard Corrosion Defense System™ with e-coat delivers automotive-grade corrosion resistance against the elements and wear and tear.
- ▶ **The Ultimate In Comfort**
 From the moment you sit in the comfortable high-back seat, you'll know you're in for a great ride. Padded armrests, adjustable steering column, an easy-lift deck height adjuster and the ISO mounted foot base that reduces vibrations through the operator's feet are just a few of the features that make this rider great for all-day operation.



Best-In-Class Deck



Unbeatable Durability

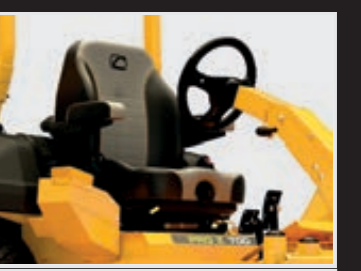

The Ultimate In Comfort



WARRANTY

3-year unit domestic & commercial warranty.
3-year engine domestic & commercial warranty.
5-year fabricated deck shell domestic warranty.

PRO Z 900 S SERIES

- PRO Z 972 S
(See page 43 for more details)

Kawasaki
— ENGINES —



BEST IN CLASS STRENGTH AND DURABILITY

Combining incredible strength with amazing all-day comfort, the PRO Z 972 S is tough to beat. The biggest challenges are no match for the advanced power of the Kawasaki® engine and strength of the triple-7-gauge deck. Heavy-duty construction, faster mowing speeds, our largest deck yet and superior comfort all make the PRO Z 972 S the ideal zero turn for large crews working on the toughest, most extensive jobs.

- Best In Class Deck**
Stand up to the toughest conditions with the only commercial lawn mower touting a triple-7-gauge steel cutting deck complete with 7-gauge top and bottom reinforcements, plus ¼" leading edge and 5/16" side reinforcements. The extra-tough fabricated deck offers added durability that features anti-scalping wheels at the front and side of the deck to give your lawn a professional looking cut.
- Unbeatable Durability**
The Cub Cadet Triple Guard Corrosion Defense System™ with e-coat delivers automotive-grade corrosion resistance against the elements and wear and tear.
- Work Hard, Ride Easy**
Experience a smooth ride all day long with PRO Z comfort features. Our exclusive Air-Ride seat allows riders to adjust seat firmness to their personal preference. The isolation dampening system under the seat reduces vibration, while angle adjustment and lumbar support provide a customised mowing experience.



Best-In-Class Deck



Unbeatable Durability



The Ultimate In Comfort



WARRANTY

3-year unit domestic & commercial warranty.
3-year engine domestic & commercial warranty.
5-year fabricated deck shell domestic warranty.



PRO Z 900 SD SERIES

- PRO Z 972 SD
(See page 43 for more details)

Kawasaki
— ENGINES —



Synchro-Steer™
Technology



STRENGTH, DURABILITY AND KING OF THE HILLS

When it comes to the PRO Z 972 SD, you won't be disappointed in the unmatched durability, stability and performance. Engineered with a first-of-its-kind drive system that includes four-wheel steering, as well as dual rear wheels for the ultimate in traction, the 972 SD cuts comfortably on steep 25° terrain. With superior comfort for all day mowing and the heavy-duty construction of the PRO Z 900 Series, the 972 SD is the ultimate mowing solution for landscapers and commercial users.

- Unmatched Hillside Confidence**
 Oversized dual rear wheels give greater stability and precision. Four-wheel steering allows you to comfortably mow a straight line, execute zero-degree turns and operate on a hillside up to a 25° slope.
- Time Saving Electric Deck Lift**
 The easy to operate, single switch electronic powered deck lift requires less effort to lift or adjust the deck than standard foot operated deck lifts saving you time and energy.
- Work Hard, Ride Easy**
 Experience a smooth ride with PRO Z comfort features. Our exclusive Air-Ride seat allows riders to adjust seat firmness to their personal preference. The isolation dampening system under the seat reduces vibration, while angle adjustment and lumbar support give a custom feel.

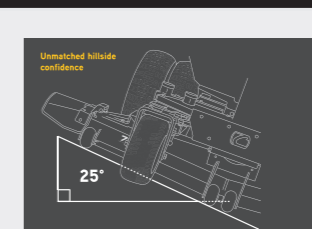

Unmatched Hillside Confidence



Electric Deck Lift



The Ultimate In Comfort



WARRANTY

3-year unit domestic & commercial warranty.
 3-year engine domestic & commercial warranty.
 5-year fabricated deck shell domestic warranty.

PRO Z 900 SDL SERIES

- PRO Z 972 SDL
 - (See page 43 for more details)

Kawasaki
 ENGINES



30 DEGREES OF COMFORT

The PRO Z 972 SDL is a dual-wheel commercial zero-turn engineered to dominate steep hills with up to a 25° slope or 46% of grade. With its unmatched maintenance-free deck, superior cutting performance and self-levelling Air-Ride comfort seat, this best-in-class mower is the ultimate mowing solution for municipalities, commercial operators and large properties with varying terrain.

- **Unmatched Hillside Confidence**
 Oversized dual rear wheels give greater stability and precision. Four-wheel steering allows you to comfortably mow a straight line, execute zero-degree turns operate on a hillside up to a 25° slope.
- **Time Saving Electric Deck Lift**
 The easy to operate, single switch electronic powered deck lift requires less effort to lift or adjust the deck than standard foot operated deck lifts saving you time and energy.
- **Maximised Comfort**
 Experience a smoother ride with the self-levelling Air-Ride seat that lets you operate with up to 15° of self-levelling side-to-side as well as the ability to adjust seat firmness to your personal preference for the ultimate in stability and comfort. The isolation dampening system under the seat reduces vibration, while angle adjustment and lumbar support provide a custom mowing experience.

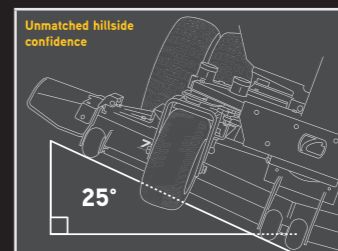

Unmatched Hillside Confidence



Electric Deck Lift

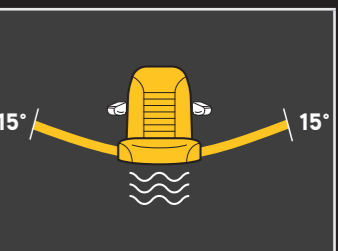







Self-Levelling Seat For Maximised Comfort

ENDURO SERIES

| SELECTION GUIDE | XT1 LT 42 | XT1 LX 42 | XT2 LX 42 | XT2 LX 46 |
|----------------------------|---|--|-----------------------------------|---------------------------|
| ENGINE | | | | |
| Engine Type | 547cc Cub Cadet Single OHV w/IntelliPower™ | 24HP Kawasaki® V-Twin OHV | 679cc Cub Cadet V-Twin OHV, EFI | 24HP Kawasaki® V-Twin OHV |
| Fuel Tank Capacity | 11.4 litres | | 9.5 litres | 11.4 litres |
| DRIVE SYSTEM | | | | |
| Transmission | Hydro, Foot (Tuff Torq) | | Auto-Diff Hydro, Foot (Tuff Torq) | |
| Cruise Control | Standard | | | |
| CONTROLS | | | | |
| Steering Control | Standard steering wheel | | | |
| Start Type | Key | | Push Button Start (PBS) | Key |
| Mow In Reverse | Standard | | | |
| CUTTING DECK | | | | |
| Cutting Width | 107cm (42"), pressed steel | | 117cm (46"), fabricated steel | |
| Height Adjustment | 12-position | | | |
| Deck Blade Engagement | Manual, lever | Electronic fingertip engagement allows you to easily engage and disengage the mowing deck saving you time and energy | | |
| Deck Wash | Patented SmartJet™ high-pressure deck washing system | | | |
| CHASSIS | | | | |
| Frame | Heavy-duty 9-gauge steel frame | | | |
| Front / Rear Tyres | Front: 15.00 x 6.00 Multi-Trac / Rear: 20.00 x 8.00 Multi-Trac | | | |
| COMFORT | | | | |
| Seat | High-back | High-back with armrests | | |
| ADDITIONAL FEATURES | | | | |
| Additional Features | Turning radius 41cm (16") and front bumper standard | | | |
| WARRANTY* | | | | |
| Warranty | Unit: 6-year domestic and 90 day commercial / Engine: 6-year domestic and 90 day commercial | | | |

ACCESSORIES

| | | | | | | | | | | | |
|---|---|--|--|---|--|---|--|---|--|---|---|
|  | Mulch Kit - 42" Deck Fits: XT1 LT 42/ LX 42 & XT2 LX 42 Part No 19A70041100 |  | Mulch Kit - 46" Deck Fits: XT2 LX 46 Part No 19B30005100 |  | Front Bumper Kit - Fits: XT1 LT 42 Part No 19A30020100 |  | Double Bagger Catcher - Fits: XT1 LT 42/LX 42 & XT2 LX 42/46 Part No 19A300030EM |  | 4 Litre 4-Stroke Oil 10W30 Part No 333-000-0004 |  | 20 Litre 4-Stroke Oil 10W30 Part No 330-000-0010 |
|---|---|--|--|---|--|---|--|---|--|---|---|

RZT® S SERIES

| SELECTION GUIDE | RZT® S 42 | RZT® S 46 | Z-FORCE® SX 48 | Z-FORCE® SX 54 |
|----------------------------|---|-------------------------------|---|-------------------------------|
| ENGINE | | | | |
| Engine Type | 21.5HP Kawasaki® V-Twin OHV | 23HP Kawasaki® V-Twin OHV | 24HP Kawasaki® V-Twin OHV | |
| Fuel Tank Capacity | 10.6 litres | | Twin 10.6 litre fuel tanks and 21.2 litres total to keep you mowing longer | |
| DRIVE SYSTEM | | | | |
| Transmission | Dual Hydro-Gear® EZT-2200 | | Dual Hydro-Gear® ZT-3100 | |
| Cruise Control | Standard | | Standard, foot-operated | |
| CONTROLS | | | | |
| Steering Control | Four-wheel steering with steering wheel control | | Four-wheel steering with steering wheel control | |
| Mow In Reverse | Standard | | Standard | |
| CUTTING DECK | | | | |
| Deck Construction | 13-gauge stamped | 11-gauge fabricated | 11-gauge with 2-gauge reinforcement and 7-gauge top plate | |
| Cutting Width | 107cm (42"), pressed steel | 117cm (46"), fabricated steel | 122cm (48"), fabricated steel | 137cm (54"), fabricated steel |
| Height Adjustment | 8-position | | 15-position | |
| Deck Blade Engagement | Electronic fingertip engagement allows you to easily engage and disengage the mowing deck | | Electronic fingertip engagement allows you to easily engage and disengage the mowing deck | |
| CHASSIS | | | | |
| Frame | Heavy-duty 12-gauge one piece, full-length steel frame | | Heavy-duty 12-gauge one-piece, full-length steel frame | |
| Front / Rear Tyres | Front: 13.00 x 5.00 / Rear: 18.00 x 8.50 | | Front: 13.00 x 6.50 / Rear: 22.00 x 9.50 | |
| COMFORT | | | | |
| Seat | High-back with armrests | | High-back EVC seat with armrests for all day comfort | |
| ADDITIONAL FEATURES | | | | |
| Additional Features | Rear bumper standard | | Rear bumper standard | |
| WARRANTY* | | | | |
| Warranty | Unit: 6-year domestic and 90 day commercial / Engine: 6-year domestic and 90 day commercial | | Unit: 3-year domestic and 1-year commercial / Engine: 3-year domestic and 1-year commercial. 5-year fabricated deck shell | |







ACCESSORIES

| | | | | | | | | | | | |
|--|--|--|--|---|---|--|--|--|--|---|--|
|  | Mulch Kit - 42" Deck Fits: RZT® S 42 Part No 19A70041100 |  | Mulch Kit - 46" Deck Fits: RZT® S 46 Part No 19B30005100 |  | Double Bagger Catcher - 42" & 46" Decks Fits: RZT® S 42/46 Part No 19C700200EM |  | Mulch Kit - 48" Deck Fits: Z-Force® SX 48 Part No: 19A70037100 |  | Mulch Kit - 54" Deck Fits: Z-Force® SX 54 Part No: 19A70038100 |  | Triple Bagger Catcher - 48" & 54 Decks Fits: Z-Force® SX 48/54 Part No: 19A70040100 |
|--|--|--|--|---|---|--|--|--|--|---|--|

ULTIMA SERIES

| SELECTION GUIDE | ZT1 42 | ZT1 46 | ZT2 54 |
|-----------------------------|--|-------------------------------------|---|
| ENGINE | | | |
| Engine Type | 21.5HP Kawasaki® V-Twin OHV | 23HP Kawasaki® V-Twin OHV | |
| Fuel Tank Capacity | 13.2 litres, centre mounted | | |
| DRIVE SYSTEM | | | |
| Transmission | Dual Hydro-Gear® EZT-2200 | | Dual Hydro-Gear® ZT-2800 |
| Forward / Reverse Speeds | Up to 12km/h / 6km/h | | |
| CONTROLS | | | |
| Steering Control | Over-moulded soft-touch ergo grip lap bars with integrated parking brake system | | |
| CUTTING DECK | | | |
| Deck Construction | 13-gauge pressed steel deck | 11-gauge AeroForce™ fabricated deck | 11-gauge flat top fabricated deck |
| Cutting Width / Blades | 107cm (42") / twin blade | 117cm (46") / twin blade | 137cm (54") / triple blade |
| Deck Blade Engagement | Electronic fingertip engagement | | |
| Deck Lift / Height | Foot-operated / 15-position / dial adjust / 3.8cm - 11.4cm (1.5" - 4.5") | | |
| CHASSIS | | | |
| Frame / Front Castor Mounts | Square 5cm x 5cm (2" x 2") tubular upper and lower frame structure / Rectangular 5cm x 6cm (2" x 2.5") square frame / offset | | |
| ROPS | N/A | | |
| Front / Rear Tyres | 11.00 x 6.00 (smooth) / 20.00 x 8.00 (Turf Master) | | 13.00 x 6.50 (smooth) / 20.00 x 12.00 (Turf Master) |
| COMFORT | | | |
| Seat | Premium high-back adjustable seat | | Premium high-back adjustable seat with cushioned armrests & ball-bearing seat slide |
| Floor Mat | Rubber | | |
| ADDITIONAL FEATURES | | | |
| Additional Features | Dual LED headlights, multi-tool and removable floor pan | | |
| WARRANTY* | | | |
| Warranty | Unit: 3-year domestic and 90 day commercial / Engine: 3-year domestic and 90 day commercial. 5-year fabricated deck shell. | | |







ACCESSORIES

| | | | | | | |
|--|--|--|---|---|---|--|
|  Mulch Kit - 42" Deck Fits: ZT1 42 Part No 19A70041100 |  Mulch Kit - 46" Fab Deck Fits: ZT1 46 Part No 19B30005100 |  Mulch Kit - 54" Fab Deck Fits: ZT2 54 ("I" deck only) Part No 19A30042100 |  Double Bagger Catcher - Fits: ZT1 42 & ZT1 46 Part No 19A70054100 |  Double Bagger Catcher - Fits: ZT2 54 Part No 19A70055100 |  4 Litre 4-Stroke Oil 10W30 Part No 333-000-0004 |  20 Litre 4-Stroke Oil 10W30 Part No 330-000-0010 |
|--|--|--|---|---|---|--|

ULTIMA SERIES

| SELECTION GUIDE | ZTX5 48 | ZTX5 54 | ZTX5 60 |
|-----------------------------|--|----------------------------|----------------------------|
| ENGINE | | | |
| Engine Type | 23HP Kawasaki® V-Twin OHV | 24HP Kawasaki® V-Twin OHV | |
| Fuel Tank Capacity | Fuel Tank 20.8 litres, centre mounted | | |
| DRIVE SYSTEM | | | |
| Transmission | Dual Hydro-Gear® ZT-3200 | | |
| Forward / Reverse Speeds | Up to 14km/h / 6km/h | | |
| CONTROLS | | | |
| Steering Control | Over-moulded soft-touch ergo grip lap bars with integrated parking brake system | | |
| CUTTING DECK | | | |
| Deck Construction | 10-gauge AeroForce Max™ fabricated deck with 2-gauge reinforcement and 7-gauge side wraps plus skid plate | | |
| Cutting Width / Blades | 122cm (48") / triple blade | 137cm (54") / triple blade | 152cm (60") / triple blade |
| Deck Blade Engagement | Electronic fingertip engagement | | |
| Deck Lift / Height | Foot operated / 15-position / dial adjust / transport mode / 3.8cm - 11.4cm (1.5" - 4.5") | | |
| CHASSIS | | | |
| Frame / Front Castor Mounts | Rectangular 4cm x 8cm (1.5" x 3") tubular upper and lower frame structure / Rectangular 4cm x 8cm tubular frame / offset / front caster suspension | | |
| ROPS | Foldable, Roll Over Protection System designed to keep you safe when mowing on difficult terrain | | |
| Front / Rear Tyres | 13.00 x 6.50 (smooth) / 23.00 x 12.00 (Turf Master) | | |
| COMFORT | | | |
| Seat | Premium automotive class high-back adjustable seat with cushioned armrests, ball-bearing seat slide and patented suspension system | | |
| Floor Mat | Rubber | | |
| ADDITIONAL FEATURES | | | |
| Additional Features | Dual LED headlights, multi-tool and removable floor pan | | |
| WARRANTY* | | | |
| Warranty | Unit: 3-year domestic and 2-year commercial / Engine: 3-year domestic and 2-year commercial. 5-year fabricated deck shell. | | |

ACCESSORIES

| | | | | | |
|---|---|--|---|--|--|
|  Mulch Kits - ZTX5 48 ZTX5 54 Part No 19A70064100 (ZTX5 48) Part No 19A70065100 (ZTX5 54) |  Mulch Kit - 60" Fab Deck Fits: ZTX5 60 Part No 19A70066100 |  Triple Bagger Catcher - Fits: ZTX5 48 Part No 49A70001100 |  Triple Bagger Catcher - Fits: ZTX5 54/60 Part No 49A70002100 |  PRO P C5 PRO PR Premium Gloves |  PRO PS PRO PC PRO PSP Safety Glasses |
|---|---|--|---|--|--|

HW PRO SERIES

SELECTION GUIDE

| | PRO HW 336 |
|------------------------|--|
| ENGINE | |
| Engine Type | Commercial-grade 14.5HP Kawasaki® engine (603cc) |
| CUTTING | |
| Cutting Width / Blades | 91cm (36") 10-gauge steel fabricated deck with 7-gauge top and bottom reinforcements / 2 high-lift Marbain® blades |
| CONTROLS | |
| Operator Controls | Single-lever cruise control with single-knob straight line tracking adjustment |
| STEERING | |
| Steering | Hand-lever steering control with ball bearing linkage for a smooth feel |
| WARRANTY* | |
| Warranty | Unit: 3-year domestic and 2-year commercial / Engine: 3-year domestic and 3-year commercial. 5-year fabricated deck shell. |
| ACCESSORIES | |
| Sulky Attachment | Quick attach with quick release function for effortless self-propelled mowing. |



PRO X SERIES

SELECTION GUIDE

| | PRO X 648 |
|----------------------------|--|
| ENGINE | |
| Engine Type | 22HP Kawasaki® FX691v V-Twin OHV |
| DRIVE SYSTEM | |
| Transmission | 12cc Hydro-Gear® pumps / 240cc Parker wheel motors |
| CUTTING DECK | |
| Deck Construction | 10-gauge shell with 7-gauge top and bottom reinforcements |
| Cutting Width / Height | 122cm (48") fabricated steel deck / 3.8cm (1-1/2") - 12.7cm (5") |
| Deck Blade Engagement | Electronic with quick reset |
| CHASSIS | |
| Frame | 5cm (2") x 7.6 (3") full-length tube frame |
| ADDITIONAL FEATURES | |
| Additional Features | Electric starter, hour meter, fuel gauge, key switch, throttle, choke, 3-position operator cushion with cargo pocket and hand lever adjust, 3-position spring suspension foot platform |
| Front / Rear Tyres | Front: 13.00 x 5.00 smooth, flat-free Rear: 24.00 x 9.50 |
| WARRANTY* | |
| Warranty | Unit: 3-year domestic and 3-year commercial / Engine: 3-year domestic and 3-year commercial. 5-year fabricated deck shell. |

PRO Z 100 S SERIES

SELECTION GUIDE

| | PRO Z 148 S | PRO Z 154 S |
|----------------------------|--|---|
| ENGINE | | |
| Engine Type | 25HP Kohler® Confidant V-Twin OHV EFI EZT-735 | 27HP Kohler® Confidant V-Twin OHV EFI EZT-745 |
| Fuel Tank Capacity | Twin 13 litre fuel tanks - 26 litres total to keep you mowing longer | |
| DRIVE SYSTEM | | |
| Transmission | Commercial-grade Dual Hydro-Gear® Transmissions with charge pumps that work at the same time to give you more power, stability and manoeuvrability for an easier cut | |
| CONTROLS | | |
| Steering Control | Four-wheel steering with steering wheel control | |
| Mow In Reverse | Standard | |
| CUTTING DECK | | |
| Deck Construction | 5/16" (.313) steel on trim and discharge sides | |
| Cutting Width | 122cm (48"), fabricated steel | 137cm (54"), fabricated steel |
| Deck Cutting Height | 15-position | |
| Deck Blade Engagement | Electric Warner® clutch - 125 Ft Lb | |
| CHASSIS | | |
| Frame | Fully-welded, full length 12-gauge channel frame with 14-gauge reinforcements | |
| Front / Rear Tyres | Front: 13.00 x 6.50 / Rear: 23.00 x 10.50 | |
| ROPS | Foldable, 3-position Roll Over Protection System designed to keep you safe when mowing on difficult terrain | |
| COMFORT | | |
| Seat | High-back EVC comfort seat with armrests, dial suspension, seat belt and 15cm (6") of seat travel | |
| ADDITIONAL FEATURES | | |
| Additional Features | Rear hitch standard | |
| WARRANTY* | | |
| Warranty | Unit: 3-year domestic and 2-year commercial / Engine: 3-year domestic and 3-year commercial. 5-year fabricated deck shell. | |

ACCESSORIES



Mulch Kit -
48" Deck
Fits: PRO Z 148 S

Part No 19A70037100



Mulch Kit -
54" Deck
Fits: PRO Z 154 S

Part No 19A70038100



Power Assist Double
Bagger Catcher -
Fits: PRO Z 148 S &
PRO Z 154 S

Part No 59A30046150



4 Litre
4-Stroke
Oil 10W30

Part No 333-000-0004



20 Litre
4-Stroke
Oil 10W30

Part No 330-000-0010

PRO Z 500 S / 700 S

| SELECTION GUIDE | PRO Z 554 S | PRO Z 760 S |
|----------------------------|--|--|
| ENGINE | | |
| Engine Type | 27HP Kawasaki® FX850v V-Twin OHV, 852cc | 31HP Kawasaki® FX921v V-Twin OHV, 999cc |
| Fuel Capacity | Twin 28 litre fuel tanks - 56 litres in total to keep you mowing longer | |
| DRIVE SYSTEM | | |
| Transmission | Parker 12cc pumps and 260cc wheel motors | Parker 14cc pumps and 280cc wheel motors |
| CONTROLS | | |
| Steering Control | High performance steering wheel with electronic power steering and foot-pedal control | |
| Mow In Reverse | Standard | |
| CUTTING DECK | | |
| Deck Construction | 7-gauge top plate, 7-gauge bottom reinforcements, 1/4" rolled leading edge | |
| Cutting Width | 137cm (54"), fabricated steel | 152cm (60"), fabricated steel |
| Deck Cutting Height | 17-position | |
| Deck Blade Engagement | Electric Warner® clutch - 125 Ft Lb | Electric Warner® clutch - 200 Ft Lb with Soft-Start |
| CHASSIS | | |
| Frame | Fully-welded, full-length 3/8 x 5" laser cut steel / integrated tie-down slots | |
| Front / Rear Tyres | Front: 15.00 x 6.00 (Kenda K505) / Rear: 24.00 x 12.00 (Kenda performance tread) | Front: 16.00 x 6.50 (Turf Saver) / Rear: 24.00 x 12.00 (Turf Tread) |
| ROPS | Foldable, 3-position Roll Over Protection System designed to keep you safe when mowing on difficult terrain | |
| COMFORT | | |
| Seat | High-back dial suspension with EVC cushion, adjustable angle back and arm rests | High-back dial suspension with EVC cushion, adjustable angle back and padded arm rests, lumbar adjustment and ISO mounts |
| ADDITIONAL FEATURES | | |
| Additional Features | Rear hitch standard | |
| WARRANTY* | | |
| Warranty | Unit: 3-year domestic and 3-year commercial / Engine: 3-year domestic and 3-year commercial. 5-year fabricated deck shell. | |

| ACCESSORIES | | | | | |
|---|---|--|---|--|---|
|  | Mulch Kit - 54" Deck Fits: PRO Z 554 S |  | Mulch Kit - 60" Deck Fits: PRO Z 760 S |  | Power Assist Triple Bagger Catcher - Fits: PRO Z 554 S & PRO Z 760 S |
| Part No 19A70038100 | | Part No 19A70039100 | | Part No 59A30047150 | |
| | | |  | 4 Litre 4-Stroke Oil 10W30 | Part No 333-000-0004 |
| | | |  | 20 Litre 4-Stroke Oil 10W30 | Part No 330-000-0010 |

PRO Z 900 S / SD / SDL

| SELECTION GUIDE | PRO Z 972 S | PRO Z 972 SD | PRO Z 972 SDL |
|----------------------------|--|--|---------------|
| ENGINE | | | |
| Engine Type | 35HP Kawasaki® FX1000 V-Twin OHV, 999cc | | |
| Fuel Capacity | Twin 28 litre fuel tanks - 56 litres in total to keep you mowing longer | | |
| DRIVE SYSTEM | | | |
| Transmission | Parker 16cc pumps and 310cc wheel motors | | |
| CONTROLS | | | |
| Steering Control | High performance steering wheel with electronic power steering and foot-pedal control | | |
| Mow In Reverse | Standard | | |
| CUTTING DECK | | | |
| Deck Construction | 7-gauge top plate, 7-gauge bottom reinforcements, 1/4" rolled leading edge | | |
| Cutting Width | 183cm (72"), fabricated steel | | |
| Deck Cutting Height | 17-position | | |
| Deck Blade Engagement | Electric Warner® PTO clutch - 225 Ft Lb with Soft-Start | | |
| CHASSIS | | | |
| Frame | Fully-welded, full-length 3/8 x 5" laser cut steel / integrated tie-down slots | | |
| Front / Rear Tyres | Front: 16.00 x 6.50 Turf Saver (w/weighted rim) / Rear: 26.00 x 12.00 | Front: 16.00 x 6.50 (Turf Saver with weighted rim) / Rear: Dual TERRA TRAC Tread 25.00 x 9.00 (18" TRAC width) | |
| ROPS | Foldable, 3-position Roll Over Protection System designed to keep you safe when mowing on difficult terrain | | |
| COMFORT | | | |
| Seat | High-back, quick adjust Air Ride suspension with EVC cushion, adjustable angle back and padded arm rests, lumbar adjustment and ISO mounts | High-back, swivel platform quick adjust Air Ride suspension with EVC cushion, adjustable angle back and padded arm rests, lumbar adjustment and ISO mounts | |
| ADDITIONAL FEATURES | | | |
| Additional Features | Rear hitch standard | | |
| WARRANTY* | | | |
| Warranty | Unit: 3-year domestic and 3-year commercial / Engine: 3-year domestic and 3-year commercial. 5-year fabricated deck shell. | | |

| ACCESSORIES | | | | | PPE | | |
|--|--|---|----------------------------|---|-----------------------------|---|---------------------------------|
|  | Mulch Kit - 72" Deck Fits: PRO Z 972 S/SD/SDL |  | 4 Litre 4-Stroke Oil 10W30 |  | 20 Litre 4-Stroke Oil 10W30 |  | PRO P QB Earplugs / Earmuffs |
| Part No 59A30053150 | | Part No 333-000-0004 | | Part No 330-000-0010 | |  | PRO P C100 |
| | | | | | |  | PRO P UT |
| | | | | | |  | PRO P 32 |
| | | | | | |  | PRO P H Straw Sun Hat |



YOUR AUTHORISED CUB CADET® DEALER MAKES YOUR EXPERIENCE EVEN BETTER.

Cub Cadet dealers know their equipment. And they know how to take care of it and their customers. You'll get exceptional financing, great offers and the expertise you can only find from professionals who sell and service Cub Cadet equipment every day.

Strongest support in the industry: Visit cubcadet.com.au or call 1300 951 594.



BUILT IN AMERICA SINCE 1961

For more than half a century, Cub Cadet lawn and garden equipment has been proudly Built in America. Established in 1961, Cub Cadet continues to be designed, engineered and built using the highest quality components sourced locally and globally. Cub Cadet is a brand that represents American ingenuity at its best. Based in Valley City, Ohio, Cub Cadet is sold worldwide.

For more information, please call **1300 951 594** or visit www.cubcadet.com.au

Not all products available at all dealers. A failure by a supplier to deliver in accordance with sample description or not at all or other unintentional causes may result in some products being unavailable. Product availability, images and specifications may change without prior notice. Images may not reflect dealer inventory or unit specifications. Engine descriptions, warranty and horsepower (HP) are by the engine manufacturer.

*For more information on our warranty, please contact your local Cub Cadet Dealer. **AUG21**